

Three speeds circulating pumps for sanitary water Dreistufige Zirkulationspumpen für Brauchwasser

TEHNICAL FEATURES / TECHNISCHE MERKMALE		SAN	SAN	SANbasic
Connections / Nenweite	DN (")	15	15, 20, 25, 32	40 - 65
Connection type / Rohranschluss		Screw Type/Gewind	Screw Type/Gewind	Flanges / Flansche
Flow max / Förderstrom max	Q (m³/h)	1,5	4/6/8	80
Pressure max / Förderhöhe	H (m)	1,5	4/6/7/8	12
Pressure rated / Betriebsdruck	PN (bar)	6	10	6 / 10
Power max / Leistungsaufnahme max	P (W)	25	90	2200
Electrical voltage / Elektroanschluss	V	1 ~ 230 AC	1 ~ 230 AC	3 ~ 400 AC
Degree of protection / Schutzart	IP	42	44	43
Regulation / Regelung		yes / ja	no / nein	no / nein
Media temperature / Temperaturbereich	T(°C)	+5 do +70	+5 do +65	-10 do +65
Insulating class / Isolationsklasse		H	H	H
Casing type / Werkstoffe		bronz / bronze	bronz / bronze	bronz / bronze
Duble pump / Zwilingspumpe		no / nein	no / nein	no / nein
APPLICATIONS / EINSATZGEBIETE				
Heating / Warmwasserheizungen		✓	✓	✓
Cooling / Kaltwasseranlagen		✓	✓	✓
Sanitary water / Brauchwasser				
Climate appliances / Klimaanlage		✓	✓	✓
Industry / Industrieanlagen		✓	✓	✓
Process technique / Verfahrenstechnik				
Condensation / Kondensat				
Salt water / Meerwasser				

Pump markings / Typenschlüssel

SAN 25 / 60 - 130 (180)

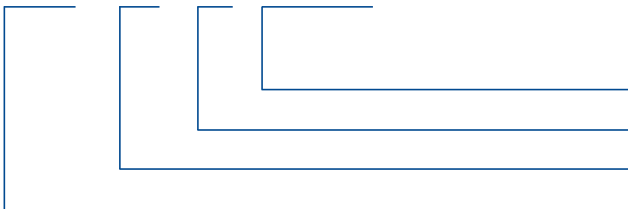

instalation lenght / einbaulänge
max head / förderhöhe
connection size / nennweite **DN**
circulating pump / Umwälzpumpe

SAN 40 - 120 F

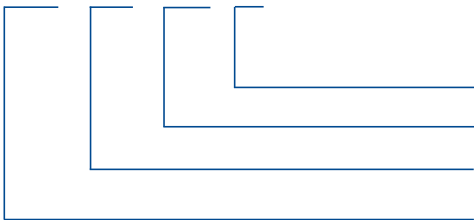

connection type - **Flange** / Rohranschluss - Flansche
max head / förderhöhe
connection size **DN** / nennweite **DN**
pump type / pumpentyp

Permitted mounting positions / Einbaumöglichkeiten

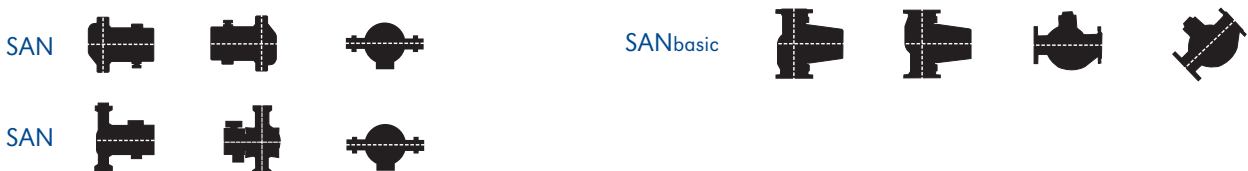

Threaded three speeds circulation pumps for sanitary water
Dreistufige Verschraubungsumwälzpumpen mit manueller
Drehzahlumschaltung

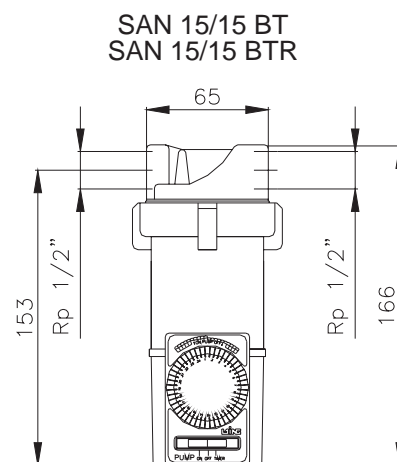
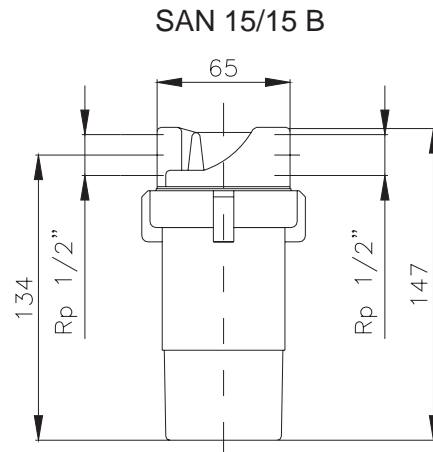

Threaded circulation pumps with three speeds for sanitary water
Dreistufige Verschraubungsumwälzpumpen mit manueller Drehzahlumschaltung

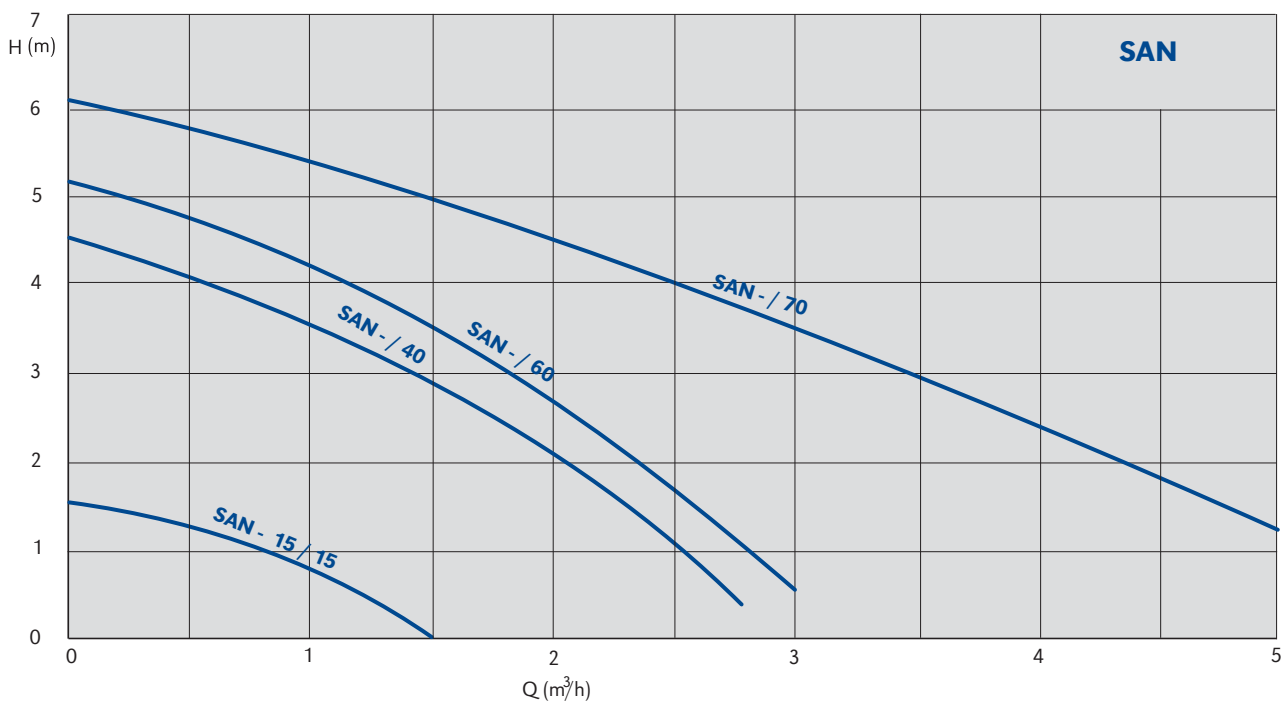
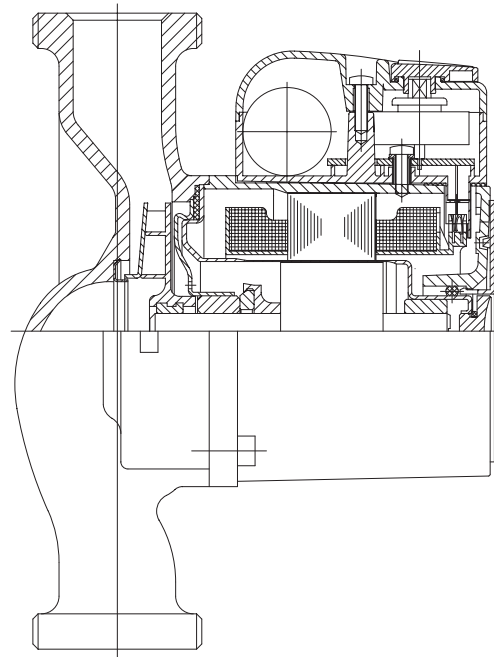

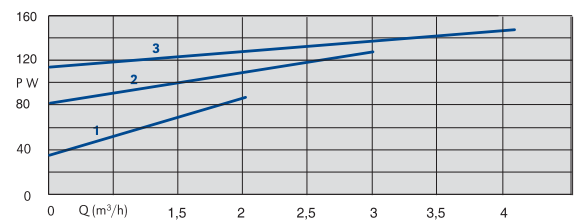
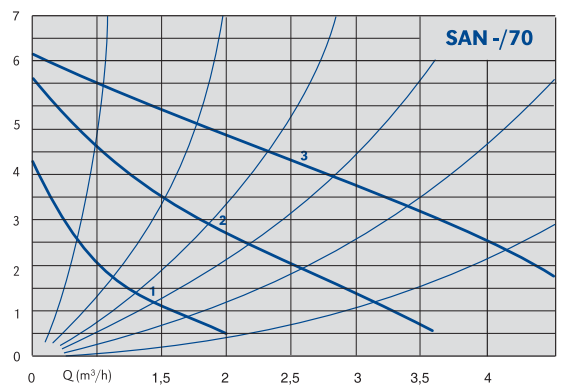
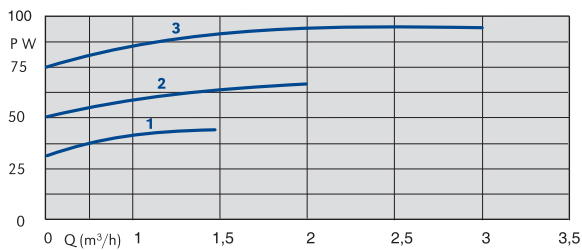
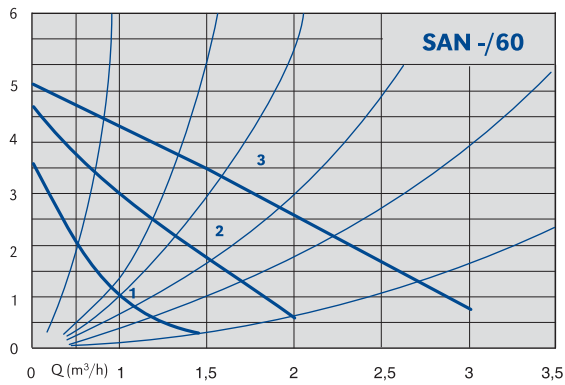
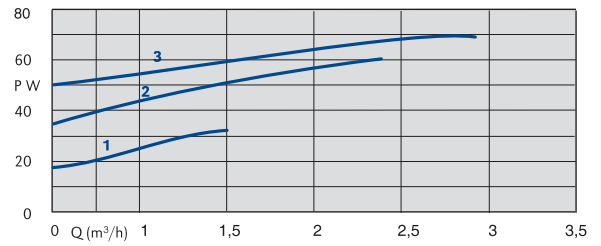
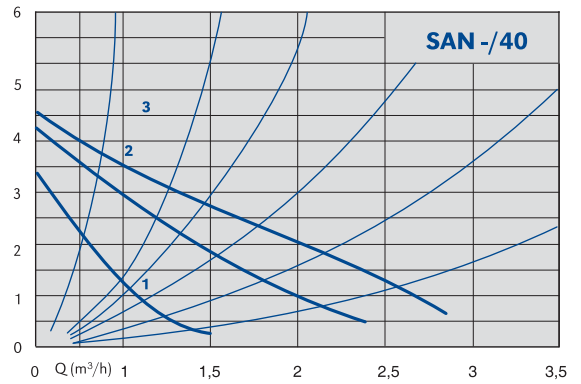
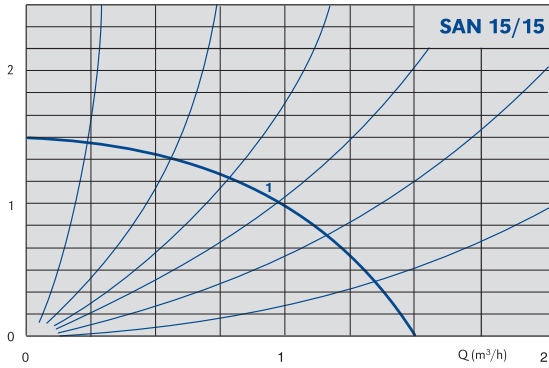

Three speeds circulation pumps for sanitary water with flanges
Dreistufige Flanschumwälzpumpen mit manueller
Drehzahlumschaltung für Brauchwasser

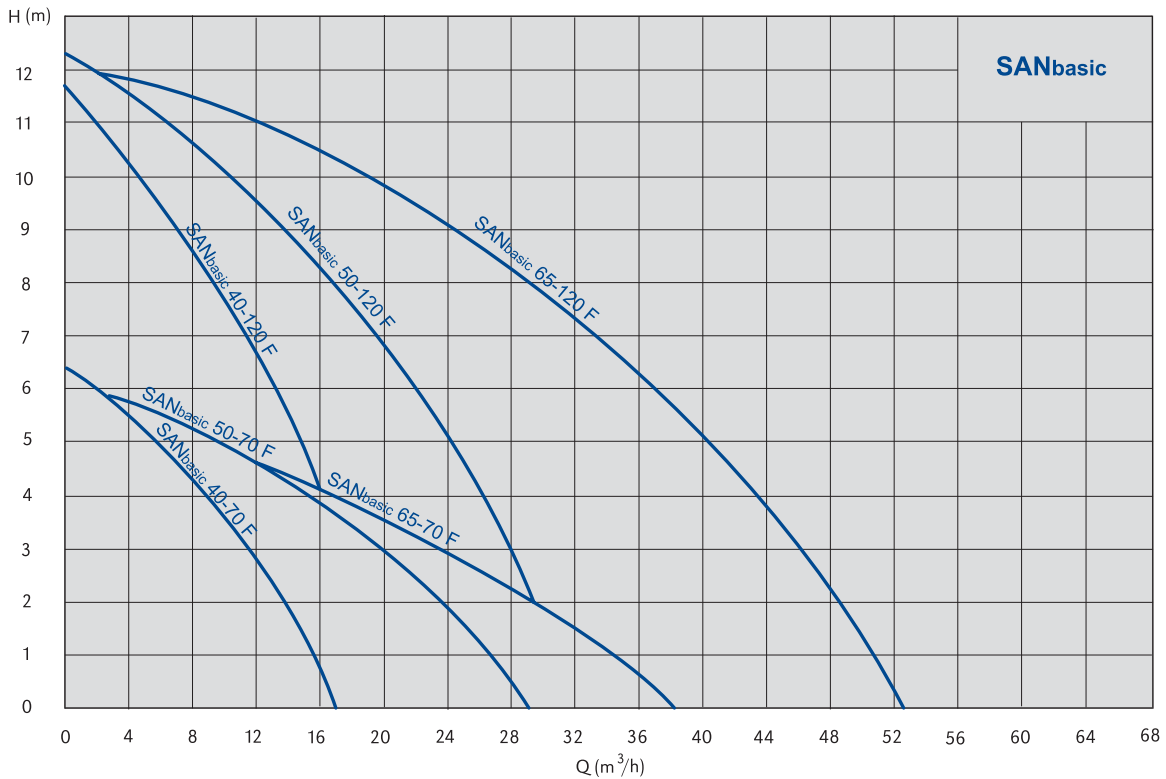

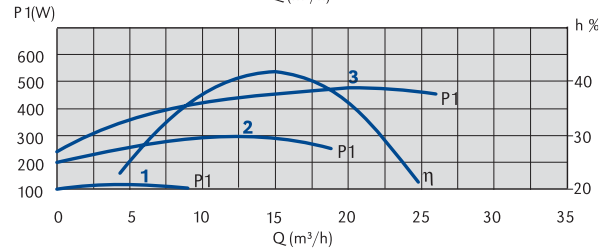
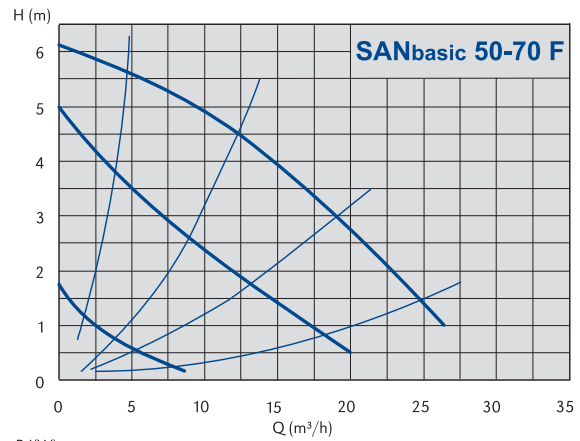
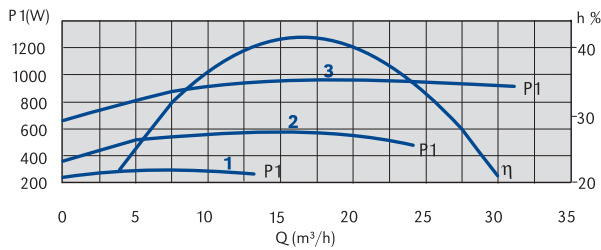
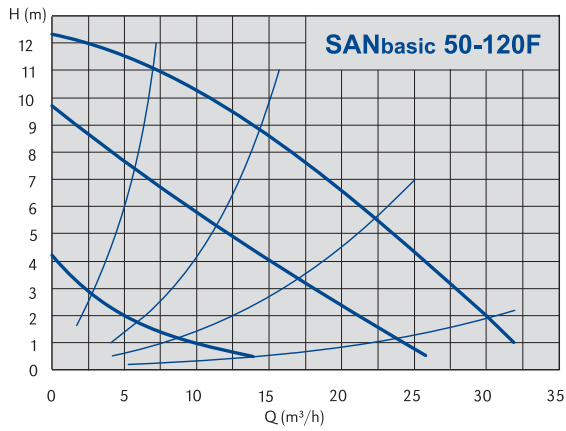
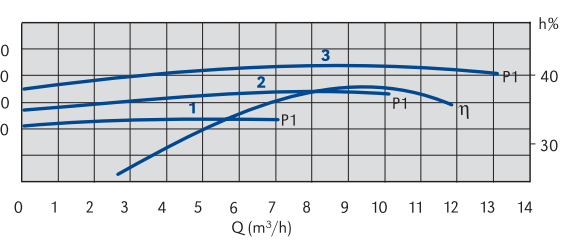
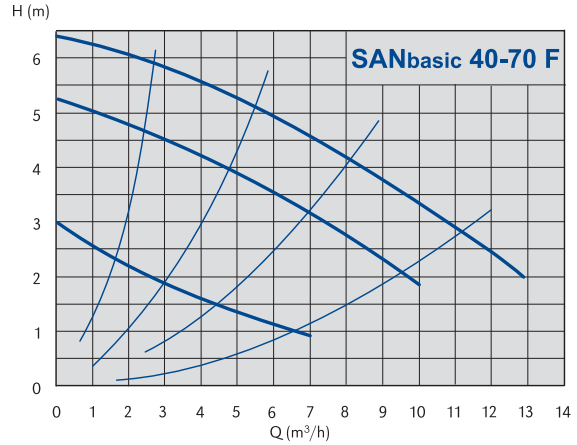
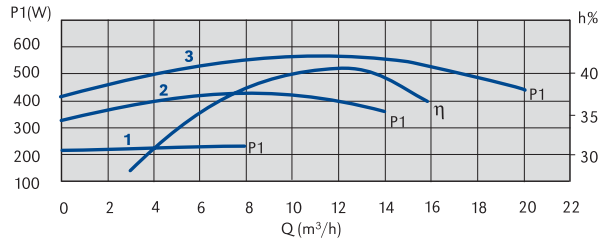
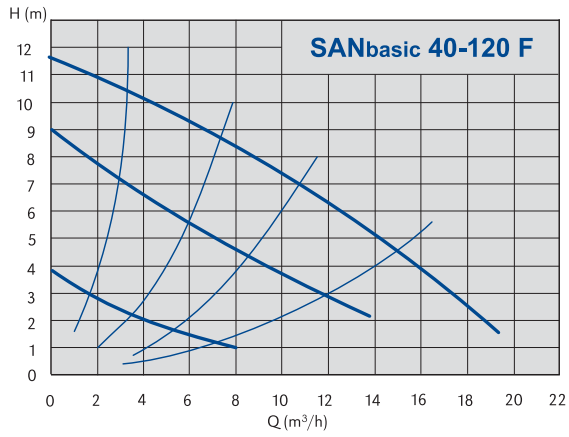

SAN / SANbasic

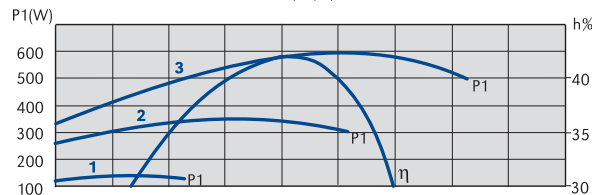
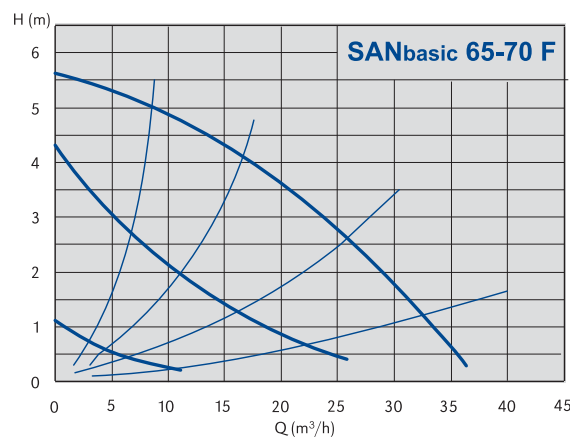
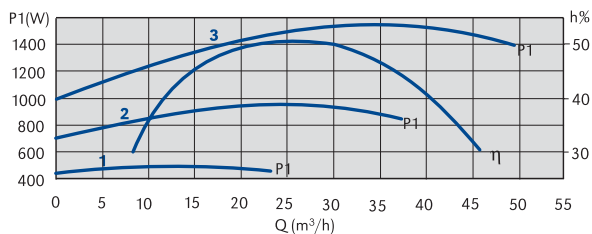
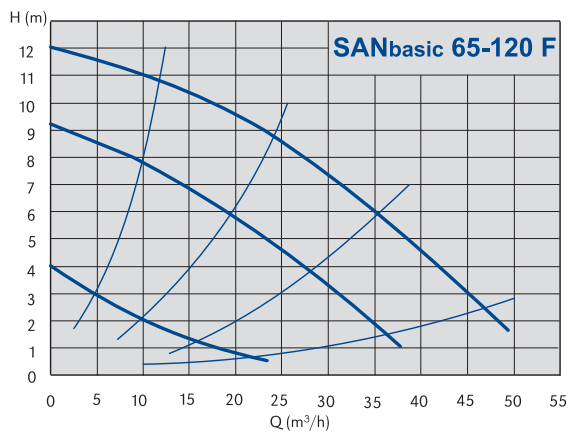

TEHNICAL DATA / TECHNISCHE DATEN

pump type pumpentyp	code artikelnummer	connection type rohranschluss	max. flow durchfluss Q (m³/h)	max. Head Förder- höhe H (m)	system pressure systemdruck PN (bar)	min. - max. media temperature temp. des medius Tmin-Tmax (°C)	casing type werkstoffe	single-S double-D einzelne-E zwillings- bauform-Z	weight gewicht (kg)	regulation geregelt yes /ja no /nein	degree of protection schutzart IP
SAN 15/15 B	L-1000001	Screw/Gewinde	1,5	1,5	PN 6	+5 - 70	bronze	S/E	1,2	no/nein	42
SAN 15/15 BT	L-1000020	Screw/Gewinde	1,5	1,5	PN 6	+5 - 70	bronze	S/E	1,4	yes/ja	42
SAN 15/15 BTR	L-1000035	Screw/Gewinde	1,5	1,5	PN 6	+5 - 70	bronze	S/E	1,4	yes/ja	42
SAN 15/40-130	979521765	Screw/Gewinde	2,8	4,5	PN 10	+5 - 65	bronze	S/E	2,3	no/nein	44
SAN 20/40-130	979521766	Screw/Gewinde	2,8	4,5	PN 10	+5 - 65	bronze	S/E	2,4	no/nein	44
SAN 25/40-130	979521767	Screw/Gewinde	2,8	4,5	PN 10	+5 - 65	bronze	S/E	2,4	no/nein	44
SAN 15/60-130	979521768	Screw/Gewinde	3	5,1	PN 10	+5 - 65	bronze	S/E	2,5	no/nein	44
SAN 20/60-130	979521769	Screw/Gewinde	3	5,1	PN 10	+5 - 65	bronze	S/E	2,6	no/nein	44
SAN 25/60-130	979521770	Screw/Gewinde	3	5,1	PN 10	+5 - 65	bronze	S/E	2,6	no/nein	44
SAN 20/70-130	979522018	Screw/Gewinde	5,2	6,2	PN 10	+5 - 65	bronze	S/E	3,8	no/nein	44
SAN 25/70-130	979522006	Screw/Gewinde	5,2	6,2	PN 10	+5 - 65	bronze	S/E	3,8	no/nein	44
SANbasic 40-120 F	979522875	Flanges/Flansche	20	12	PN 6 / 10	-10 - +65	bronze	S/E	22	no/nein	43
SANbasic 40-70 F	979522876	Flanges/Flansche	13	6	PN 6 / 10	-10 - +65	bronze	S/E	22	no/nein	43
SANbasic 50-120 F	979522877	Flanges/Flansche	30	12	PN 6 / 10	-10 - +65	bronze	S/E	28	no/nein	43
SANbasic 50-70 F	979522878	Flanges/Flansche	25	6	PN 6 / 10	-10 - +65	bronze	S/E	28	no/nein	43
SANbasic 65-120 F	979522879	Flanges/Flansche	50	12	PN 6 / 10	-10 - +65	bronze	S/E	36	no/nein	43
SANbasic 65-70 F	979522880	Flanges/Flansche	35	6	PN 6 / 10	-10 - +65	bronze	S/E	36	no/nein	43

DIMENSIONS / MAßE

	pump type pumpentyp	code artikelnummer	length einbaulänge L (mm)	connection size rohranschluss DN	a	l	b1	b2	R	b	h1
1	SAN 15/15 B	L-1000001	65	DN 15	13	134	33	33			
	SAN 15/15 BT	L-1000020	65	DN 15	13	153	33	33			
	SAN 15/15 BTR	L-1000035	65	DN 15	13	153	33	33			
2	SAN 15/40-130	979521765	130	DN 15	28	108	80	44			
	SAN 20/40-130	979521766	130	DN 20	28	108	80	44			
	SAN 25/40-130	979521767	130	DN 25	28	108	80	44			
	SAN 15/60-130	979521768	130	DN 15	28	108	80	44			
	SAN 20/60-130	979521769	130	DN 20	28	108	80	44			
	SAN 25/60-130	979521770	130	DN 25	28	108	80	44			
	SAN 20/70-130	979522018	130	DN 20	28	108	80	44			
	SAN 25/70-130	979522006	130	DN 25	30	108	80	44			
	SANbasic 40-120 F	979522875	250	DN 40	65	198	153	92			
	SANbasic 40-70 F	979522876	250	DN 40	65	198	153	92			
	SANbasic 50-120 F	979522877	280	DN 50	70	250	160	113			
	SANbasic 50-70 F	979522878	280	DN 50	70	250	160	113			
	SANbasic 65-120 F	979522879	340	DN 65	80	252	160	123			
	SANbasic 65-70 F	979522880	340	DN 65	80	252	160	123			

ELECTRICAL DATA / ELEKTRISCHE DATEN

**MIN WORKING PRESSURE (bar)
MIN ZÜLASSIGER BETRIEBSDRUCK**

	pump type pumpentyp	code artikelnummer	power max. leistung- saufnahme P (W)	speed range drehzahlstufe (min-1)	FLC I nennstrom In (A)	electrical voltage elektroanschluss I (V)	insulating class isolationsklasse	temperature / temperatur		
								50°C	80°C	110°C
1	SAN 15/15 B	L-1000001	25		0,11	230 V	F			
	SAN 15/15 BT	L-1000020	25		0,11	230 V	F			
	SAN 15/15 BTR	L-1000035	25		0,11	230 V	F			
2	SAN 15/40-130	979521765	75	1315 - 2456	0,17 - 0,33	230 V	H	0,05	0,4	1,1
	SAN 20/40-130	979521766	75	1315 - 2456	0,17 - 0,33	230 V	H	0,05	0,4	1,1
	SAN 25/40-130	979521767	75	1315 - 2456	0,17 - 0,33	230 V	H	0,05	0,4	1,1
	SAN 15/60-130	979521768	90	1080 - 1980	0,17 - 0,39	230 V	H	0,05	0,4	1,1
	SAN 20/60-130	979521769	90	1080 - 1980	0,17 - 0,39	230 V	H	0,05	0,4	1,1
	SAN 25/60-130	979521770	90	1080 - 1980	0,17 - 0,39	230 V	H	0,05	0,4	1,1
	SAN 20/70-130	979522018	140	1109 - 2340	0,39 - 0,62	230 V	H	0,05	0,4	1,1
	SAN 25/70-130	979522006	140	1109 - 2340	0,39 - 0,62	230 V	H	0,05	0,4	1,2
	SANbasic 40-120 F	979522875	578	1250 - 2820	0,36 - 1,46	3 ~ 400 V	200	0,05	0,8	1,4
	SANbasic 40-70 F	979522876	295	1440 - 2790	0,18 - 0,74	3 ~ 400 V	200	0,05	0,8	1,4
	SANbasic 50-120 F	979522877	1020	1270 - 2800	0,46 - 1,73	3 ~ 400 V	200	0,05	0,8	1,4
	SANbasic 50-70 F	979522878	470	560 - 1400	0,2 - 1,15	3 ~ 400 V	200	0,3	1	1,6
	SANbasic 65-120 F	979522879	1560	1250 - 2810	0,84 - 2,8	3 ~ 400 V	200	0,3	1	1,6
	SANbasic 65-70 F	979522880	600	450 - 1370	0,22 - 1,25	3 x 400 V	200	0,3	1	1,6

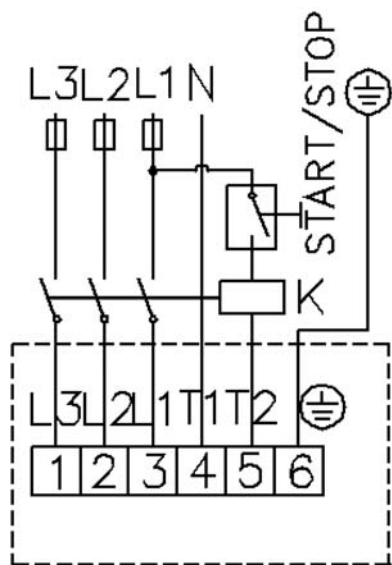
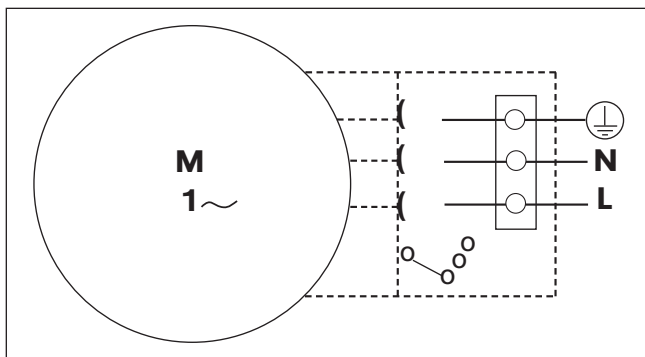
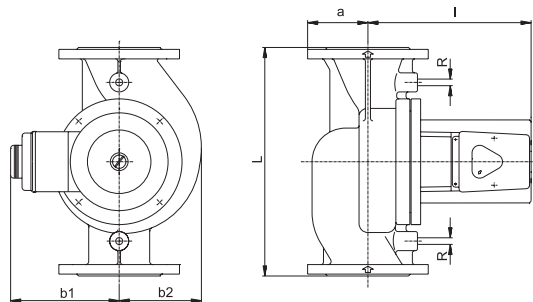
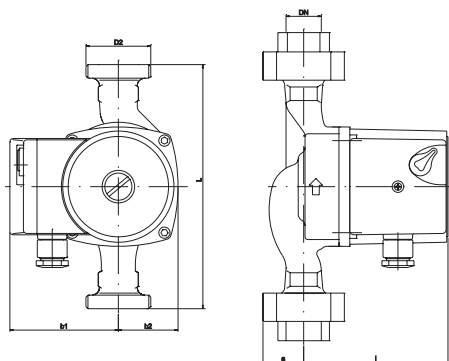

**Connection and description of electric connectors:
THREE PHASE CONNECTION**

- Terminal 1 (LR3):**
Phase L3 (T) AC power source 3-400 V/50 Hz
- Terminal 2 (L2):**
Phase L2 (S) AC power source 3-400 V/50 Hz
- Terminal 3 (L1):**
Phase L1 (R) AC power source 3-400 V/50 Hz
- Terminal 4 (T1):**
Neutral N AC power source 3-400 V/50 Hz
It is used to activate thermal protection.
- Terminal 5 (T2):**
Connection of external on/of relay.
- Terminal 6:**
Connect to the earth ground wire.