

EN



ASIN Aqua®
REDOX, CLF, DOSE, SANOSIL

ASIN Aqua

aseko.com



USER'S MANUAL

ASIN Aqua

REDOX # 12144 CLF # 12001 DOSE # 12022 SANOSIL # 12149

What you receive in your box



PE Tube 1/4"



Tube Weight 2 pc



Water Valve 2 pc



Injection Valve 2 pc



Screws and dowels



Sharp knife



Flowmeter



pH probe



Filter

Aseko POOL TESTER

or

Sanostrips

CLF chlorine free probe

or

Redox probe



Table of Contents

What you receive in your box	4	Choose the function of Your ASIN Aqua.....	22
General safety information	6	1) Free chlorine probe CLF.....	22
About ASIN Aqua	8	2) Redox probe RX	24
Understanding ASIN Aqua	9	3) Time dosing ml/m ³ per hour or per day.....	25
Installing ASIN Aqua	10	Safety functions	26
Step 1		Maximal safety dose	26
Instaling the Probes.....	12	Too rapid pH change.....	26
Step 2		The pH change without probe response	26
Connecting the measuring Water.....	13	 	
Step 3		ASIN Aqua NET	27
Connecting the disinfection agent and pH agent Dosage Tubes	14	Internet connection.....	27
Step 4		iPool Live	28
Connecting the Power Supply	15	ipool.aseko.com	29
 		External touch display	30
Language setting	15	Thermometer connection.....	30
Testing ASIN Aqua Installation	16	Thermometer calibration (ASIN Aqua NET).....	30
Manual Dosing	17	 	
 		Maintaining ASIN Aqua	31
Setting Your Pool's Parameters	17	Spare part list.....	31
Setting Pool Filtration Parameters	17	Pump Tube replacement	31
Setting Water Parameters	19	 	
 		ASIN Aqua error messaging	33
pH Settings	20		
pH Calibrating	20		

General safety information

This user manual has basic information that should be observed during assembly, start-up, operation, and maintenance. Therefore, this user manual must be read by installers and operators prior to assembly and start-up, and must be accessible to every user of this unit. Additionally, all further safety information in this document absolutely must be observed. Read and follow all instructions. In order to minimise the danger of injury, do not allow children to use this product. Hazards from non-compliance with safety information. Non-compliance with safety information can result in hazards to persons, the environment, and the equipment. Non-compliance with safety information will result in a forfeit of any potential right to damage compensation.



Insufficient personnel qualification

Hazards in the event of insufficiently qualified personnel, potential consequence: Injury, heavy material damage.

- The system operator must ensure compliance with the required qualification level.
- Any and all work may only be performed by correspondingly qualified personnel.
- Access to the system must be prevented for insufficiently qualified persons, e.g. via access codes and passwords.

Potential overdosing of chemical agents

Despite ASIN Aqua® comprehensive safety functions, it is possible that a probe failure and other

errors could lead to an overdosing of chemical agents. Potential consequence: Injury, heavy material damage.

- Design your installation such that uncontrolled dosage is not possible in the event of a probe failure or other errors, and/or such that uncontrolled dosage is recognised and halted before damage is incurred.
- Uncontrolled overdose of chemicals can cause harm to health and property. Even though the device contains a number of security elements can not be ruled out that in case of failure of the measuring probes, or the whole

device may result in overdose of chemical agents. Install the equipment so that uncontrolled overdose of chemicals was not possible and that uncontrolled overdose has been detected in time before causing any harm. It is necessary to use chemicals in such quantities that an overdose will not cause dangerous concentration of chemical agents. Do not use chemicals in too large packages or with too high concentration.

Gaseous chlorine produced from dosing in standing water if dosing outputs are not closed via the filter pump

If the flow switch is stuck or experiences another error, there is a risk of dosing into standing water. Poisonous chlorine gas can be yielded when sodium hypochlorite and pH minus come together.

Non-compliance with informational text

There is a great deal of informational text indicating hazards and their avoidance. Not observing informational text may lead to hazards. Potential consequence: gravest degree of injury, heavy material damage.

- Read all informational text carefully.
- Cancel the process if you are unable to exclude all potential hazards.

Use of new functions

Because of the continued development, a ASIN Aqua® unit may contain functions, which are not completely described in this version of the user manual. The use of such new or extended functions without a profound and secure understanding by the operator may result in malfunctions and severe problems. Potential consequence: Injury, heavy material damage.

- Make sure to get a profound and secure understanding of a function and relevant boundary conditions, before you start to use it.
- Check for an updated version of the user manual or additional documentation available for the relevant functions.
- Make use of the integrated help function of the ASIN Aqua® to get detailed information on functions and their parameter settings.
- In case it should not be possible to get a profound and secure understanding of a function based on the available documentation, do not use this function.

Overdosing if pH value is wrong

If disinfection is enabled before the pH value is stable in the ideal range of 7.0 to 7.4, then it may lead to heavy overdosing of chlorine or bromine. Potential consequence: Injury, heavy material damage.

- Do not start disinfection with chlorine or bromine until the pH value is stable in the ideal range between 7.0 and 7.4.

Conditions before using

Make sure you have a newest and updated version of the user manual and other documentation for all functions of the unit. Use and read the integrated help features. In case of not understanding the information about certain features of the unit, do not use these features.

Handling chemicals for pool water treatment.

The chemicals used with the ASIN Aqua must be handled in a safe manner to prevent damage or personal harm. Aseko recommends you always use personal protective safety equipment when handling the pH and chlorine agents. *Refer to the Materials Safety Data Sheet (MSDS).*

WARNING: Never mix the pH agent with the chlorine agent. When carrying out maintenance on the clear plastic tubes or valves always rinse with clean water to prevent mixing of the pH and chlorine agents.



About ASIN Aqua

ASEKO's ASIN Aqua gives you pool clean and sparkling water with the minimum amount of chemicals. By directly measuring and controlling the free chlorine content or redox potential of your pool water with advanced CLF (free chlorine) or redox probe. ASIN Aqua tunes your pool water using the minimum amount of chlorine, eliminating the smell and burning of over-treated pools. With a touch screen interface, you have complete control over measurement and regulation of your pool. ASIN Aqua operates with your existing pool filtering equipment. ASIN Aqua works also on time dosing system for chlorine-free oxygen based disinfection agent dosing as SANOSIL.

Power supply	230 V / 50 Hz
Power consumption	14 VA
Fuse	T80 mA
Over-voltage category	II
Ingress protection	IP50
Operating temperature and humidity	+5 to +40°C / 60%
Weight	2,2 kg
Emplacement	wall-mounted
Measured and regulated value	Free chlorine or Redox, pH
Pump power	60 ml/min. / max 1 bar
Measuring water pressure	max 1,5 bar

Understanding ASIN Aqua

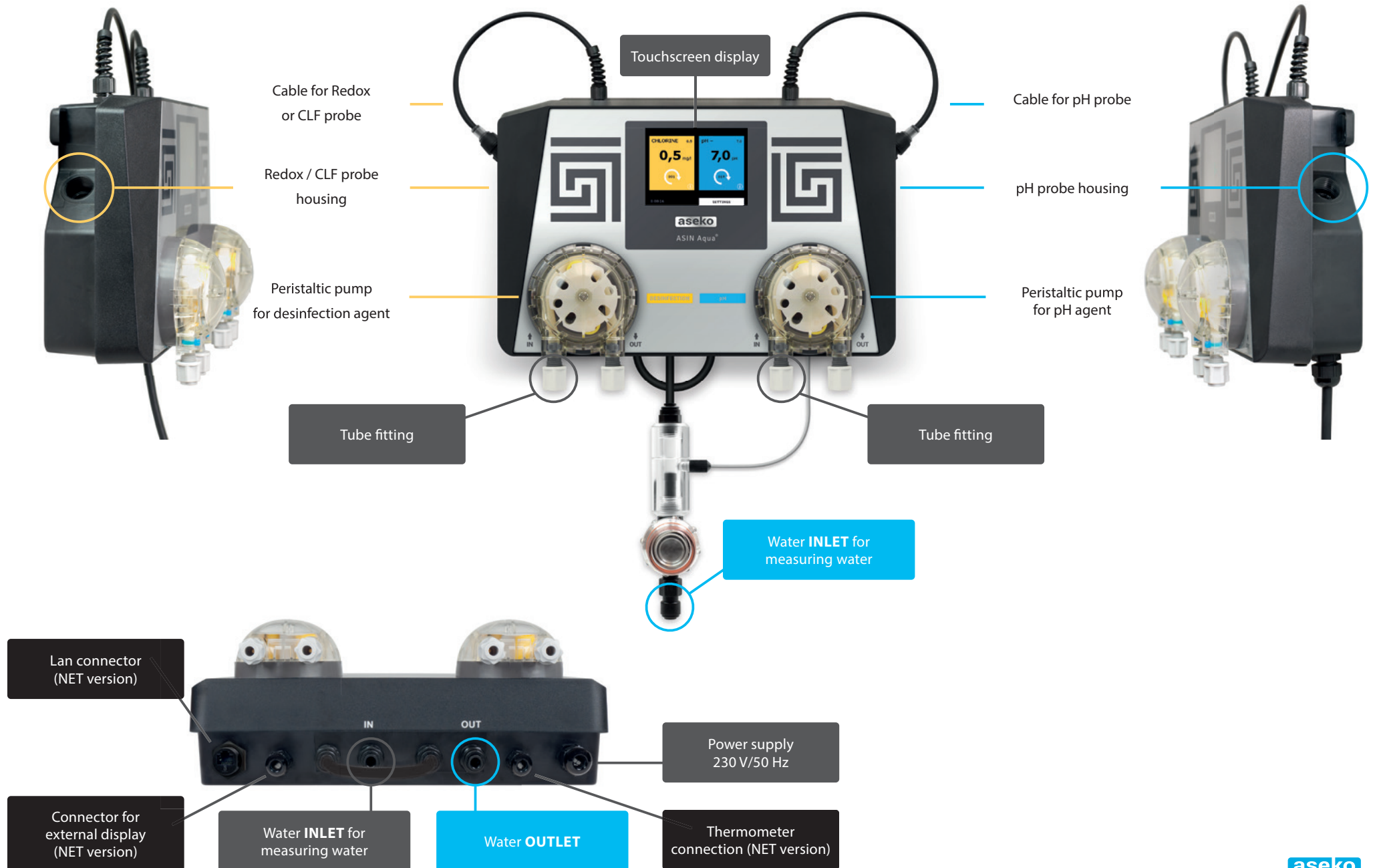

Installing ASIN Aqua

Install your ASIN Aqua in an environment free from dust and high humidity. Mount your ASIN Aqua on the wall with at least 30 cm of free space around all sides.

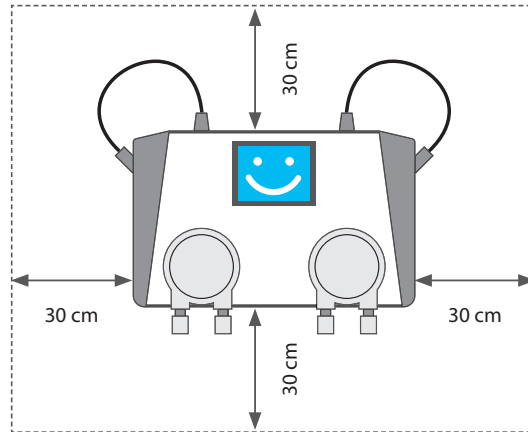
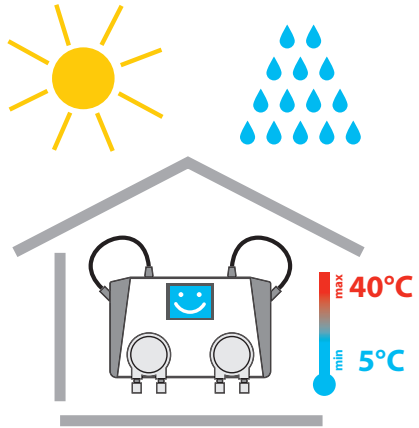

Measure, mark and drill two holes 23 centimeters apart on your wall.

Use the screws included with ASIN Aqua.

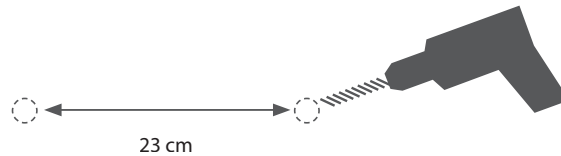

WARNING: Do not expose your ASIN Aqua to direct sunlight, damp or frost as these weather conditions cause damage. ASIN Aqua functional temperature range is 5 – 40°C.

WARNING:

- Ensure pool water is chemically clean and free from dirt before installing your ASIN Aqua.
- Do not install your ASIN Aqua more than 8 m away from the connection of the chemical agents to your pool water supply.
- Do not install your ASIN Aqua with more than a 2 m vertical difference between the fixed wall mounted position to the connection of the chemical agents.

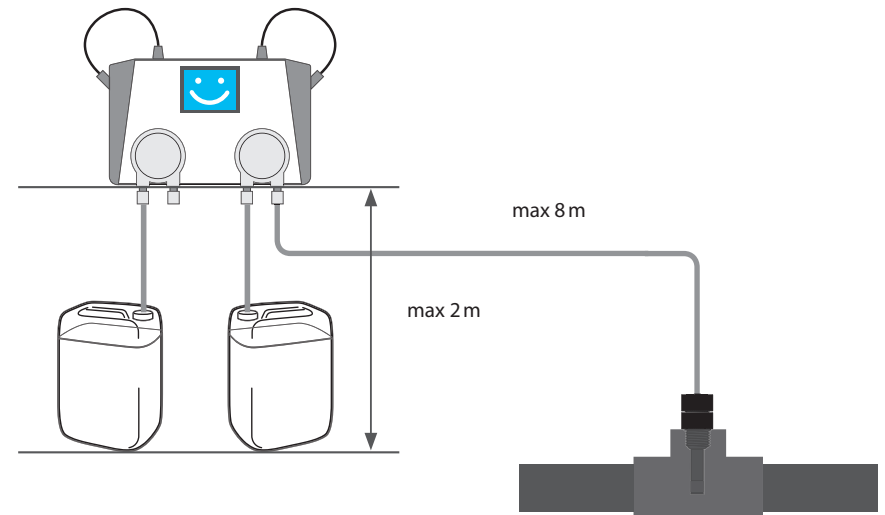

RECOMMENDATION:

Change Your pool water for fresh one.

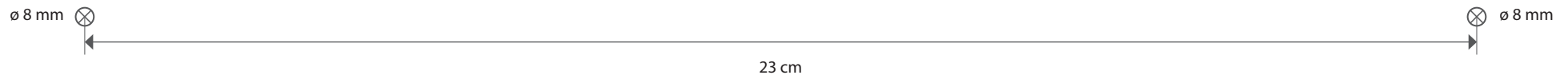

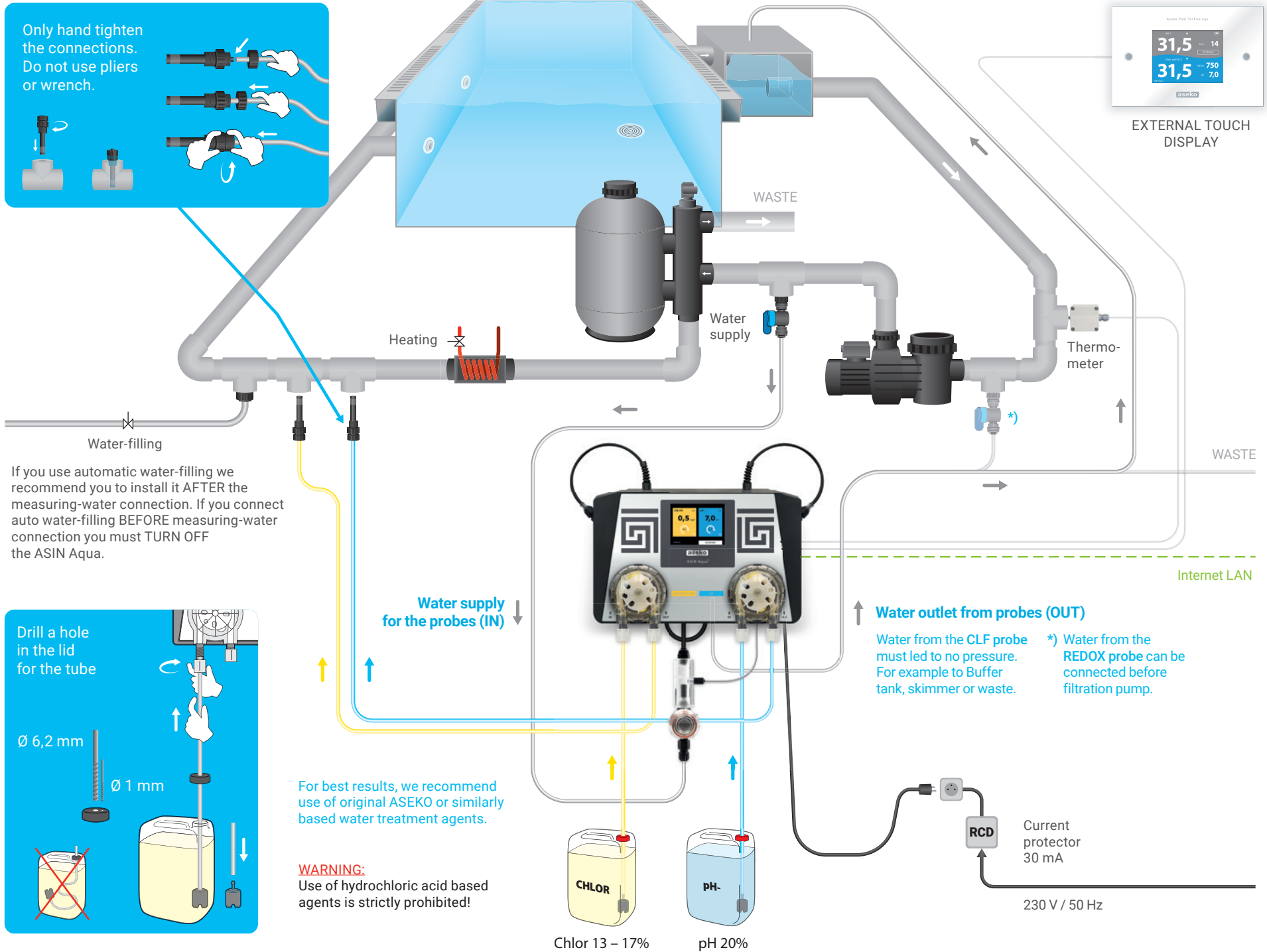

Only hand tighten the connections. Do not use pliers or wrench.

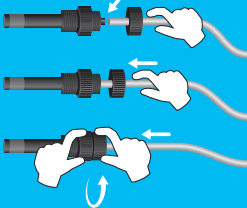
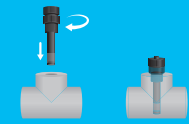

If you use automatic water-filling we recommend you to install it AFTER the measuring-water connection. If you connect auto water-filling BEFORE measuring-water connection you must TURN OFF the ASIN Aqua.

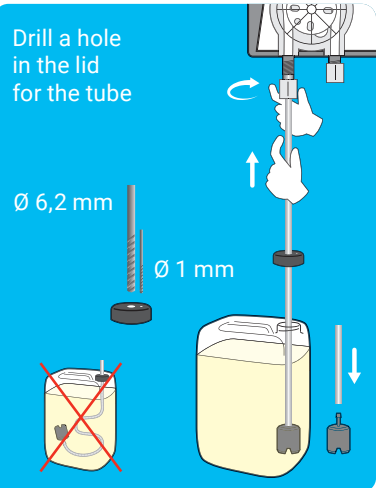

For best results, we recommend use of original ASEKO or similarly based water treatment agents.

WARNING: Use of hydrochloric acid based agents is strictly prohibited!

Chlor 13 – 17%

pH 20%



EXTERNAL TOUCH DISPLAY

Water outlet from probes (OUT)

Water from the CLF probe must led to no pressure. For example to Buffer tank, skimmer or waste.

*) Water from the REDOX probe can be connected before filtration pump.

230 V / 50 Hz

Step 1

Instaling the Probes

The CLF or Redox probe housing is on the left. The pH probe housing is on the right. These probes are used for the analysis of the content of the water in your pool. The probes allow for the accurate detection of acidity levels and the potential voltage within your pool water.

1. Insert your CLF or Redox probe in the left side of your ASIN Aqua and attach the cable using the screw fit connector.
2. Insert your pH probe in the right side of your ASIN Aqua and attach the cable using the screw fit connector.

After inserting the probes your ASIN Aqua is ready to be connected to the water system of your pool.

WARNING:

Only hand tighten the connections. Do not use pliers or wrench.

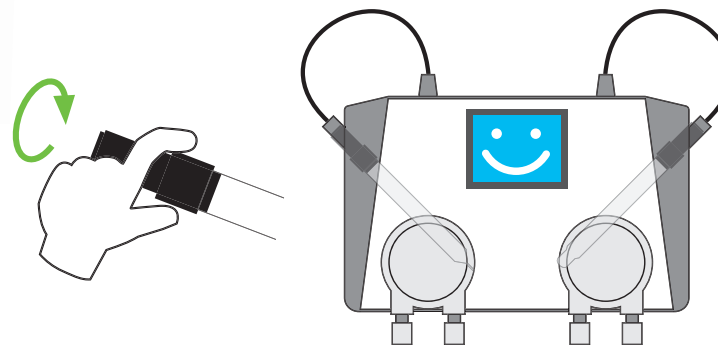
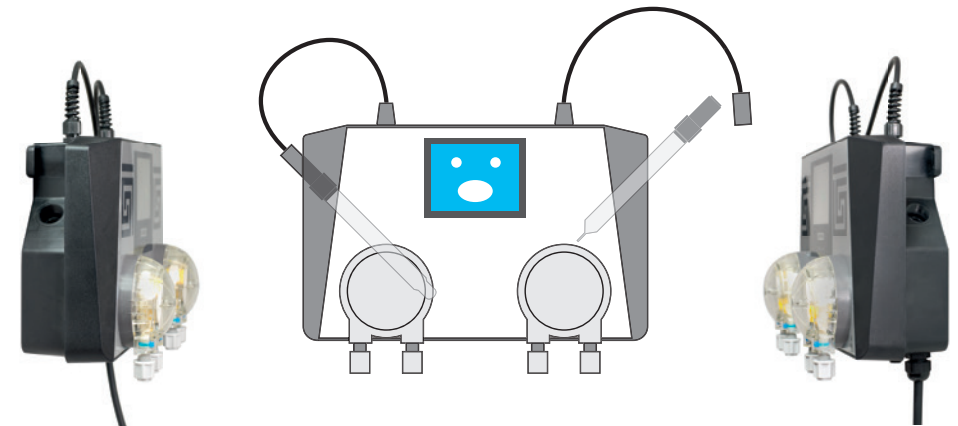
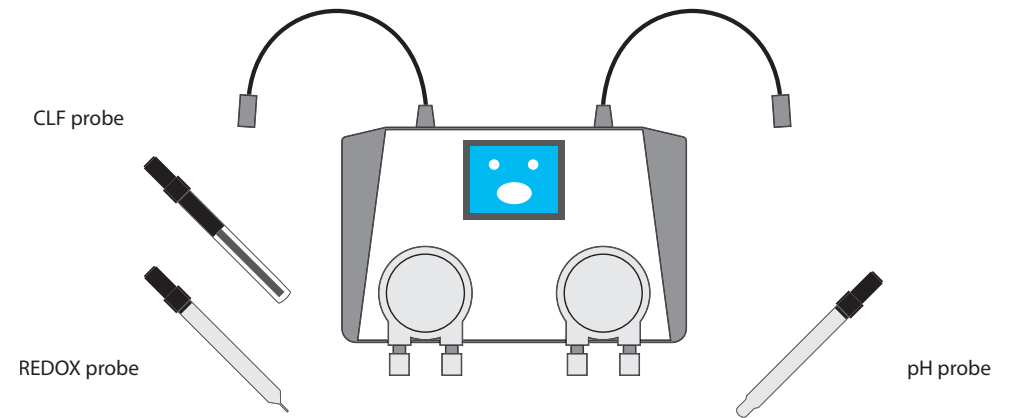

CLF chlorine free probe

or Redox probe



pH probe



Step 2

Connecting the measuring Water

ASIN Aqua requires connection to the water from your pool. Connect the supply to your ASIN Aqua after the pump and before the filter.

- Thread = G 1/4".

For the water connection to your ASIN Aqua, Aseko provides water valve with a unique Speedfit connector. To connect, push the clear plastic tube into the Speedfit connector. To remove the tube from the connector, push the collet in, and pull on the tube.

WARNING: Using pliers or cutters damages your hose and results in a poor fitting.

1. Cut your clear plastic tube at 90 degree angle to ensure proper fitting.

- Use a sharp knife or razor to cut the tubes cleanly

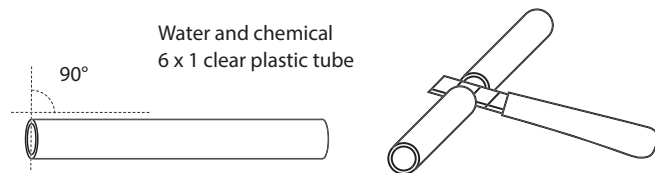

2. Connect the water input on the left and the water output on the right. Make sure the water pressure is not more than 1.5 bar.
3. The water output from your ASIN Aqua can be connected, on the tubing before the pump or to the skimmer, the buffer tank or to a drain.

After connecting the water supply, your ASIN Aqua is then set up to take samples of the water from your pool and analyze them. The analysis allows the monitoring of chlorine levels and pH levels ensuring your pool hygiene.

WARNING:

Only hand tighten the connections. Do not use pliers or wrench.

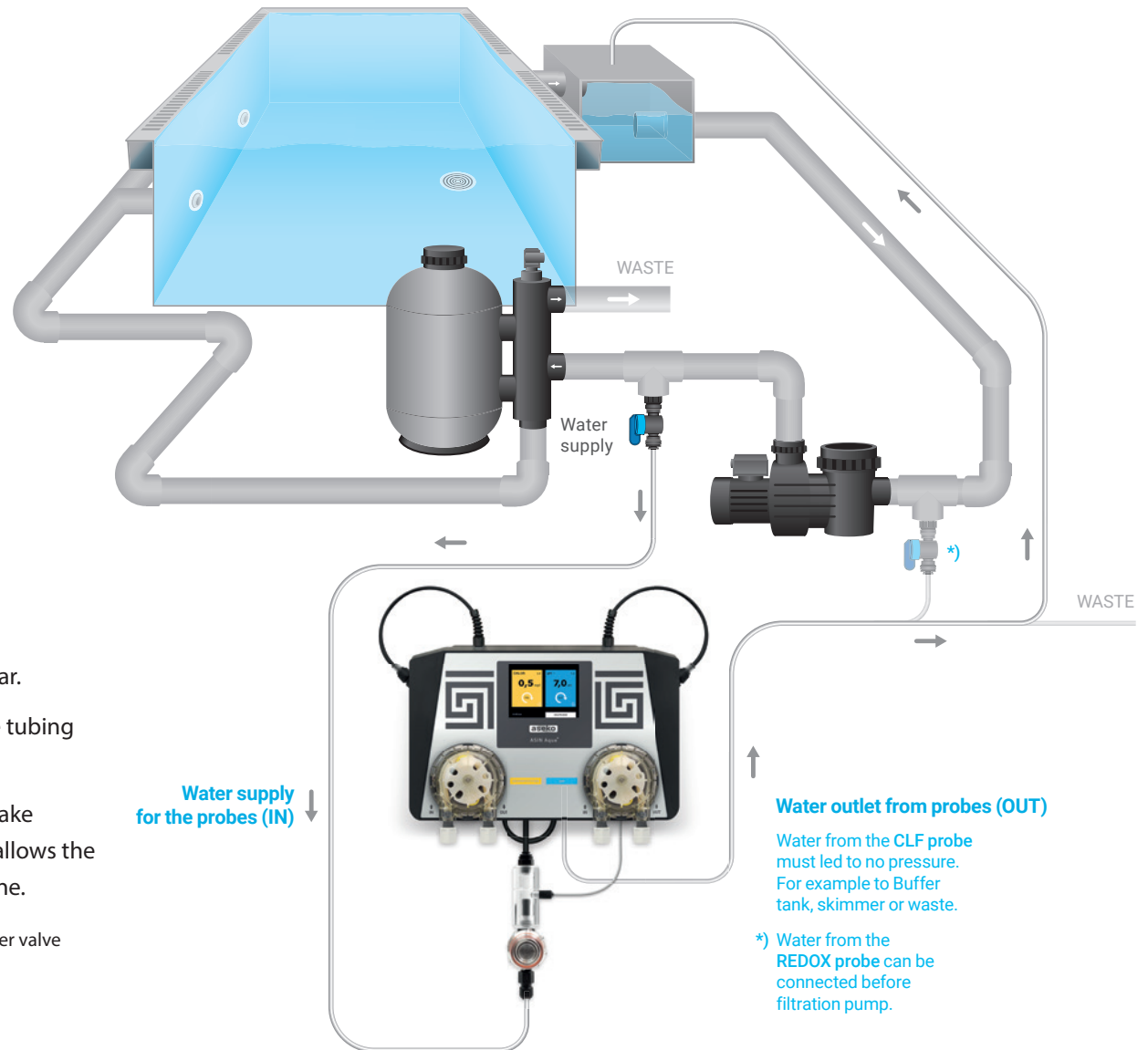
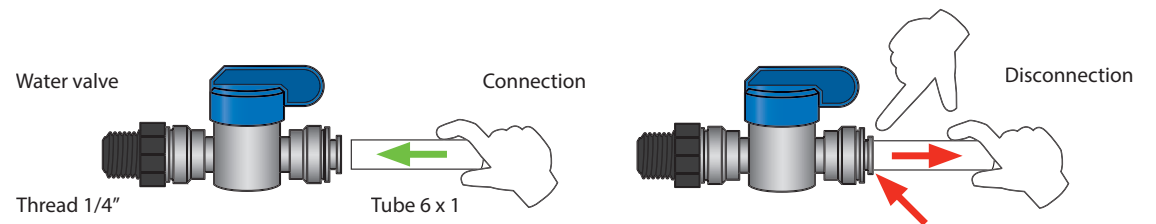
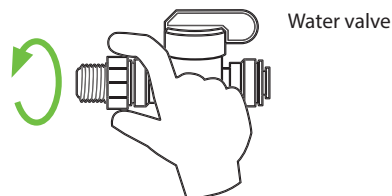

Step 3

Connecting the disinfection agent and pH agent Dosage Tubes

Connect the pH injection valve to the pool water pipe UPSTREAM from the chlorine injection valve. This reduces limescale build up.

1. Cut your clear plastic tube at 90 degree angle to ensure proper fitting.
 - Use a sharp knife or razor to cut the tubes cleanly.
2. Make a 6 mm hole in the lid of your chlorine container and push through enough clear plastic tube to reach the bottom of the container.
 - Extra tube in your container will bend and allow air bubbles into the system.
3. Attach the tube weigh to the end of your clear plastic tube.
4. Connect your clear plastic tube from the chlorine to the left side of the chlorine pump of your ASIN Aqua.
5. Connect your clear plastic tube from the right side of your chlorine pump to your chlorine injection valve.
 - Thread = G 1/4"
6. Ensure your valves are not blocked or damaged and connect to the water supply of the pool
7. Repeat the steps for your pH dosage connection using the pump on the right side.

WARNING: Only hand tighten the connections. Do not use pliers or wrench. ASIN Aqua uses a regulated amount of the chemical agents for disinfection and pH regulation ensuring optimal efficiency and consumption.

WARNING: Do NOT connect the pH to the chlorine pump, or the chlorine to the pH pump. In case of a crossed connection, after ten doses your ASIN Aqua displays an ERROR warning. Press the red ERROR button to list the faults. Correct the tube installation and then resume operation of your ASIN Aqua.

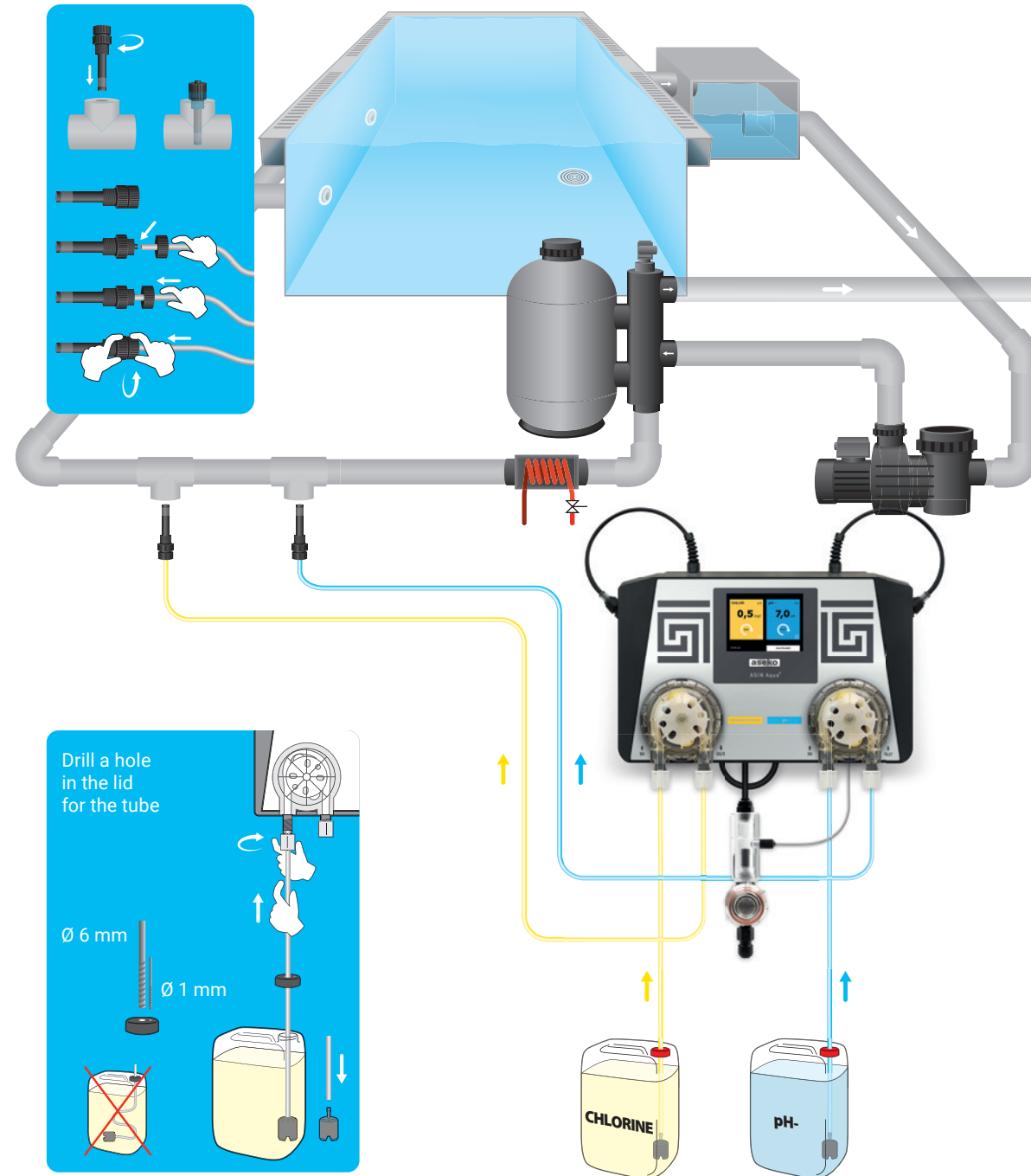

Step 4

Connecting the Power Supply

First start:

Connect ASIN Aqua to power supply 230 V / 50Hz protected by RCD.

ASIN Aqua have no ON/OFF switch after connection to power supply is automatically on. Select language and test the installation.

Turning off:

Unplug the ASIN Aqua from power supply 230 V / 50 Hz.

WARNING:

If the ASIN Aqua is used in a different manner, not specified by the manufacturer, the apparatus may not provide the full protection it is designed for

RECOMMENDED:

To frequent switching ON/OFF (more the 4x a day) can cause damage.

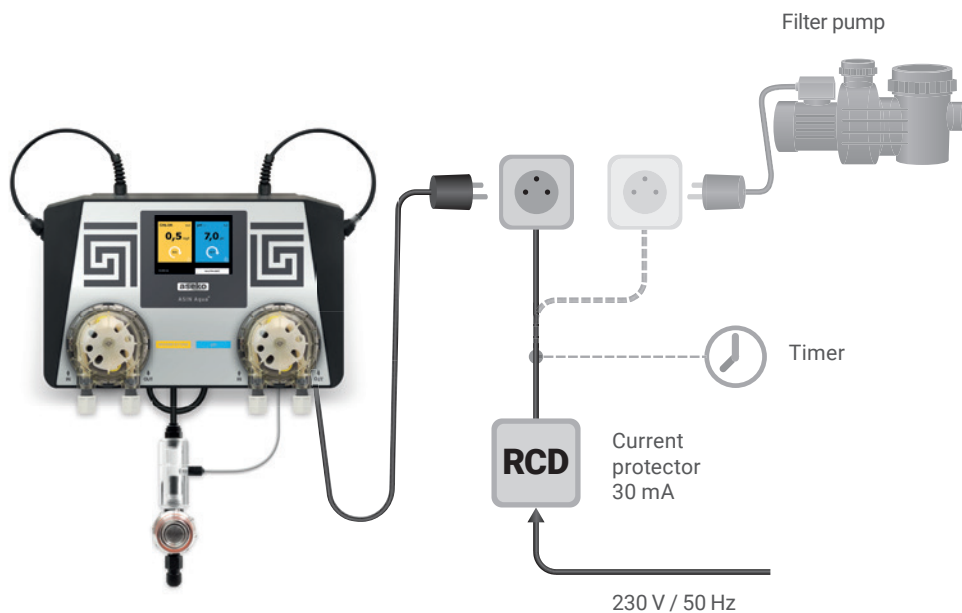

Language setting

In ASIN Aqua you can choose from different languages:

- Czech
- English
- German
- Russian
- Croatian

Setup

1. In menu press SETTINGS and select LANGUAGE.
Or in startup press LANGUAGE
2. In pop-up menu select required language then press BACK TO START

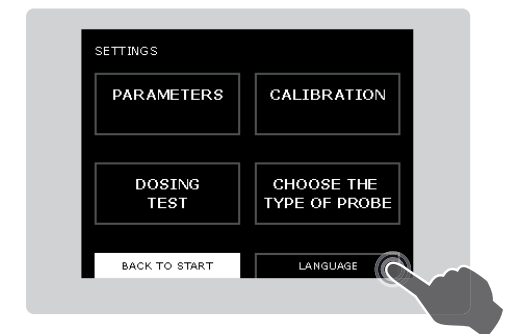

Testing ASIN Aqua Installation

WARNING: Any blocks, bubbles, or leaks in the clear plastic tube prevent ASIN Aqua from operating. The clear plastic tubing allows you to see liquid flow to and from your ASIN Aqua.

Test your ASIN Aqua installation before operating to prevent damage to the system, failure to monitor your pool, and wasting time and money. Most problems are the result of poor connections to the pH and chlorine pumps.

Using the MANUAL DOSE OF DISINFECTANT function allows you to test both pumps.

1. From the start screen select SETTINGS.

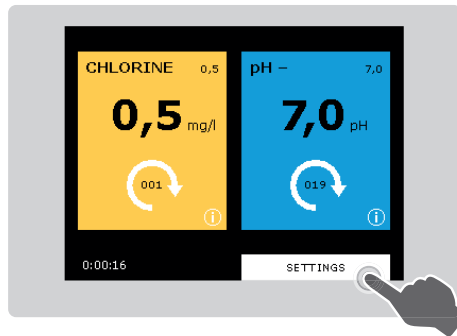

2. Select DOSING TEST

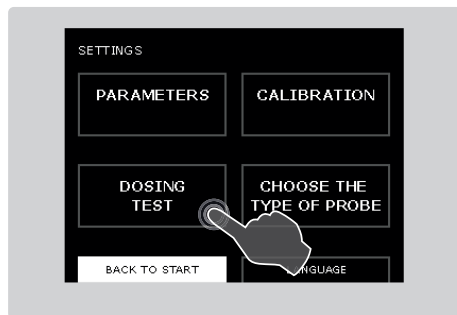

3. Select START in the yellow box on the left of the screen. This starts the chlorine pump on the left of your ASIN Aqua.
4. While the pump is running check all the connections of your clear plastic tubes to the chlorine pump. Check the valves are not blocked or leaking and that there are no air bubbles.

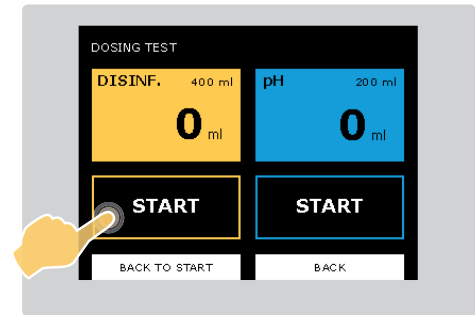

WARNING: Make sure fluid moves through the clear plastic tubes through the pumps to the pool water.

5. Select STOP.

Checking the installation and checking the pumps ensures your ASIN Aqua is integrated into your pool system.

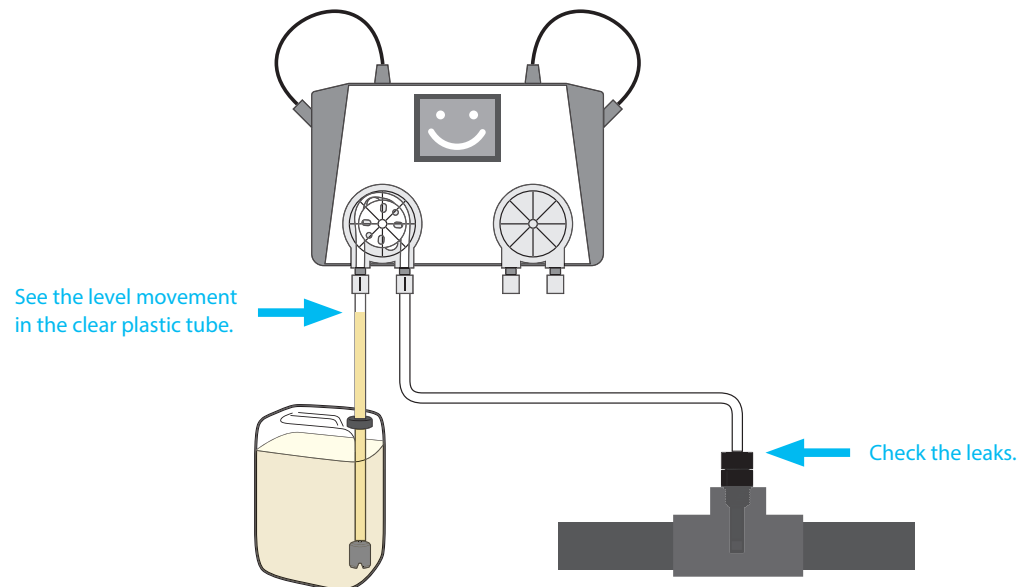
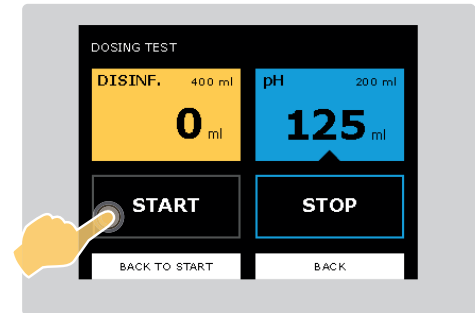

6. Select START in the blue box on the right of the screen. This starts the pH pump on the right of your ASIN Aqua.

7. While the pump is running check all the connections of your clear plastic tubes to the pH pump. Check the valves are not blocked or leaking and that there are no air bubbles.

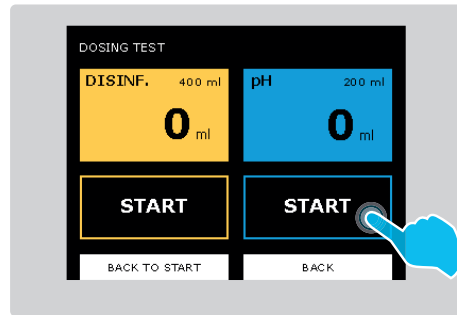

WARNING: Make sure fluid moves through the clear plastic tubes through the pumps to the pool water.

8. Select STOP.

Checking the installation and pumps ensures your ASIN Aqua is integrated into your pool system.

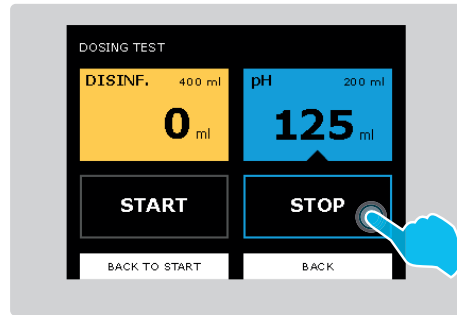

Once everything is set up with no problems, calibrate and set parameters for your ASIN Aqua.

Manual Dosing

Use Manual Dosing to raise the concentration of chlorine or pH agent within your pool. This is required if the concentration is significantly below recommended levels. You can also use Manual dosing to test the connections of the clear plastic tubes to the pH and chlorine pumps.

1. In menu select SETTINGS then MANUAL DOSE pH or disinfection.
2. In menu of manual dosing your selection is highlighted with a black triangle at the bottom.

Setting Your Pool's Parameters

Each pool is unique. Temperature, size, location, and hardness of water all affect how ASIN Aqua monitors and tunes your pool water. For optimum performance, you must set your pool properties in ASIN Aqua. After you select REQUIRED VALUES:

1. Set your Pool Filtration Parameters
2. Set your Water Parameters

Setting Pool Filtration Parameters

ASIN Aqua must know the size of your pool and how long your pool is filtered each day. When you first install ASIN Aqua you must set these pool parameters.

1. From the start screen select SETTINGS then select PARAMETERS to take you to the following screen.
2. Select POOL PARAMETERS

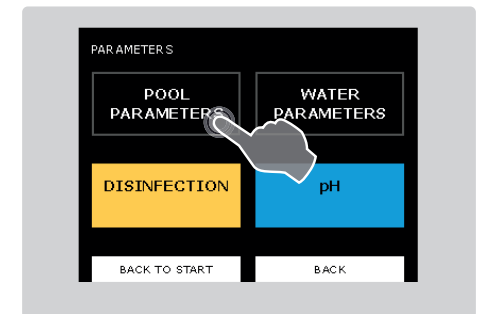
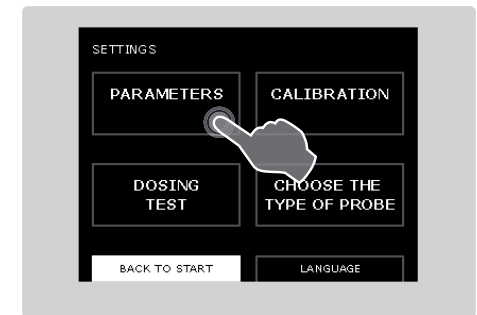

3. POOL VOLUME. Calculate the volume of your pool in cubic meters (m³) using the formula;

- Pool Length (L) multiplied by Pool Width (W) multiplied by Pool Depth (D) equals Pool Volume (V) – (L × W × D = V). Press the + and – buttons to input the correct volume of your pool and then press OK to save.

WARNING: this parameters effect on maximal hour disinfection dosage.

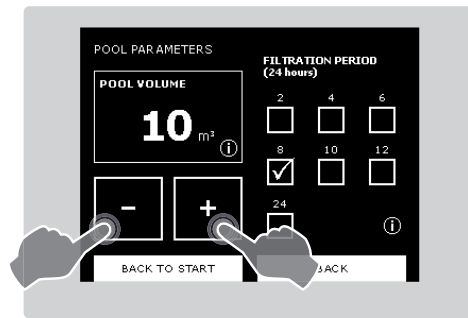

4. FILTRATION PERIOD. The figure shown shows the duration of the filtration period and **not** the frequency.

RECOMMENDATION:

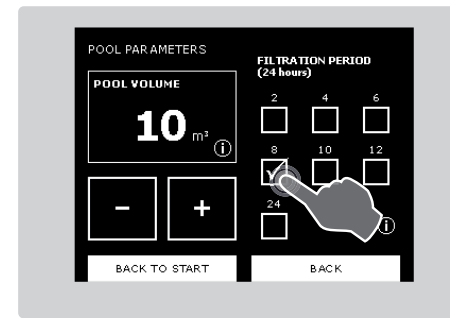

Recommended filtration period is 24 hours. Minimum filtration period is 6 hours.

After you set the ASIN Aqua Pool Filtration parameters you must set the Water Parameters. The Pool Filtration and Water parameters determine which settings ASIN Aqua uses to monitor your pool correctly.

If you change the volume of water or duration of your pool filtration, you must update your parameters.

WARNING: The filtration period must be set up as total runtime of ASIN Aqua per day.

WARNING: this parameters effect on maximal hour disinfection dosage.

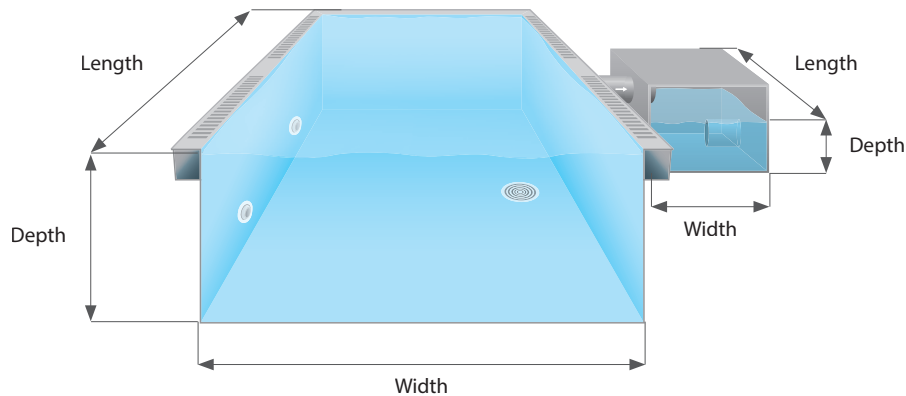

Setting Water Parameters

Water parameters tell ASIN Aqua the properties of your pool's water. ASIN Aqua includes pre-set defaults based on:

- Indoor or Outdoor pool.
- Level of water hardness.
- Average temperature of water.

Because each of these parameters has an effect on how ASIN Aqua performs, you must enter the correct water parameters to ensure ASIN Aqua operates optimally with your pool.

Set your water parameters when you install ASIN Aqua.

1. From the home screen select settings then PARAMETERS and then POOL PARAMETERS to reach the following screen.

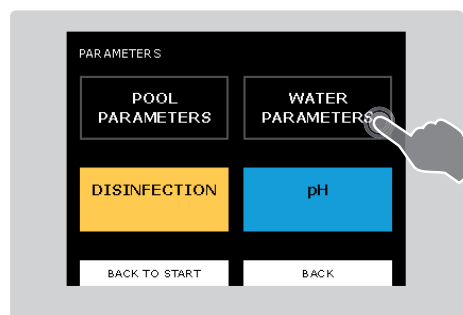
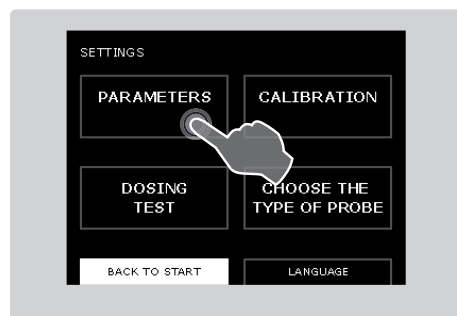

2. POOL. Using the check boxes select your type of pool:

- INDOOR
- OUTDOOR
- EXTREME CONDITIONS

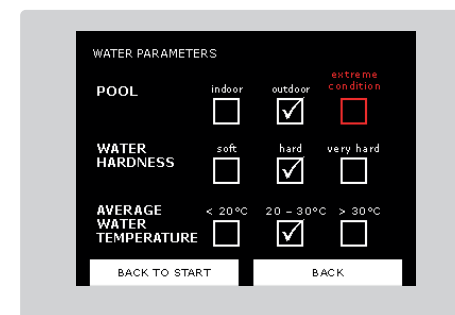

WARNING: this parameters effect on maximal hour disinfection dosage.

3. AVERAGE WATER TEMPERATURE.

Select the average temperature of the water in the pool

WARNING: this parameters effect on maximal hour disinfection dosage.

4. WATER HARDNESS. Input the level of hardness of the water in the pool.

This is measured in dH (degrees of hardness), 0 – 9 is soft, 9 – 21 is hard and 21+ is very hard.

Ensure the parameters you set match your pool before calibrating your ASIN Aqua.

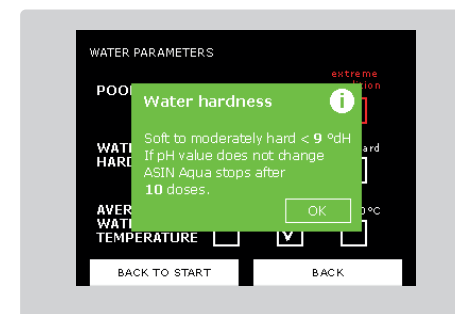
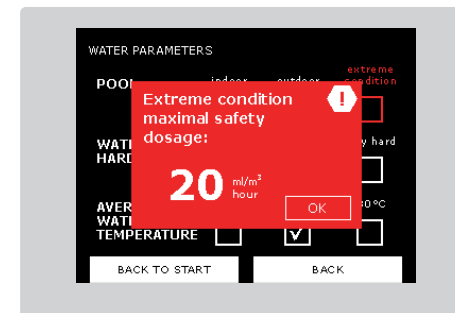
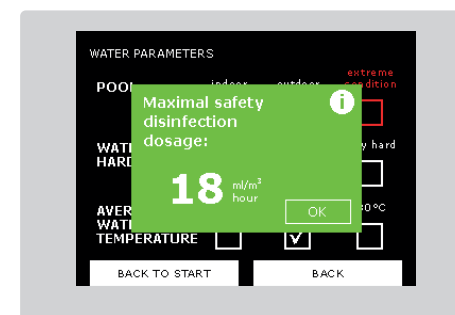

pH Settings

Setup of required values:

1. From the home screen select SETTINGS then PARAMETERS.
2. Select the blue pH button on the right.
3. Using the – and + buttons adjust the pH

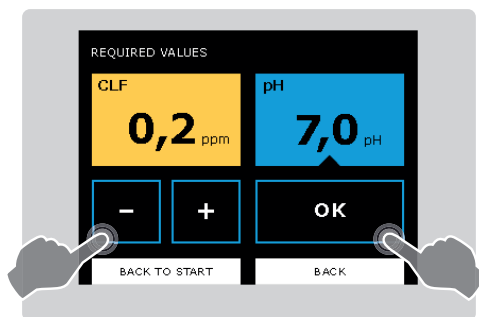
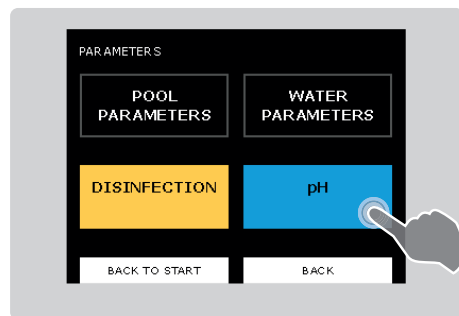
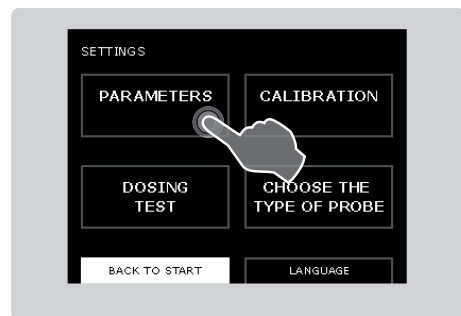

RECOMMENDATION:

Aseko Recommended pH 6,5 – 7,6.

Use low pH with pools sanitized by active oxide agent.

Use high pH with pools sanitized by salt electrolyzes systems.

For chlorine sanitized pools You can use pH 7,0.

pH Calibrating

WARNING: The probes do NOT require calibration under most circumstances.

ASEKO calibrates the ASIN Aqua pH probes at the factory.

If you do not allow the probes to stabilize in water before calibrating and using your system, ASEKO cannot ensure the accuracy of ASIN Aqua. Re-check pH calibration once a year, replacing the probe if needed.

Calibrating the ASIN Aqua pH Probe:

1. Manually check the pH level of your pool.

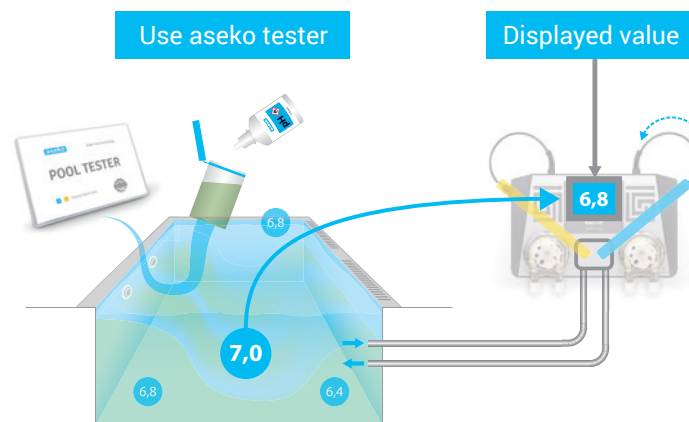

Pool Tester #12170



- From the start screen of your ASIN Aqua select SETTINGS and then CALIBRATION.
- Select the blue pH button on the right of the screen.
- Compare the reading given on your ASIN Aqua with the reading taken manually. If different adjust the reading on the ASIN Aqua by pressing the + and – buttons so that they match and press OK to save.

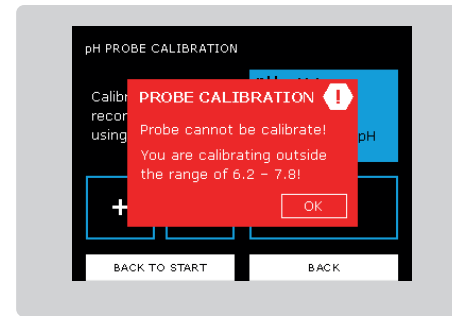
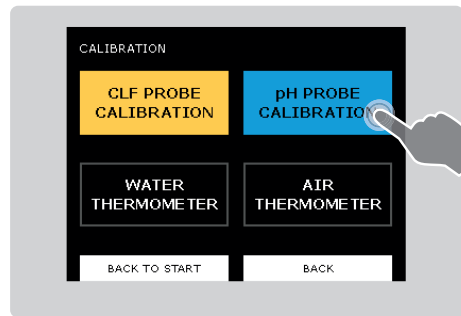
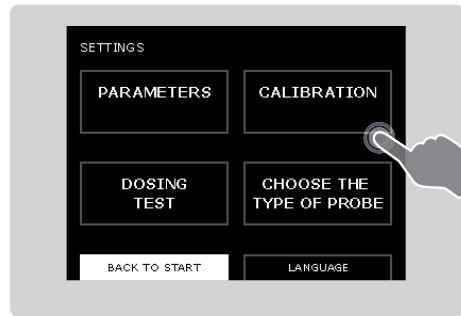

If the manually test value is outside the pH range 6,2 – 7,8 the following notification is given.

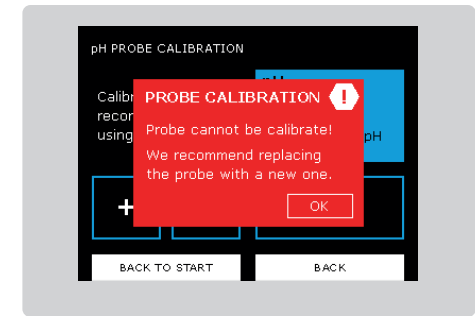

If the difference between manually test and current displayed pH valve is greater than 0,3 the following notification is given.

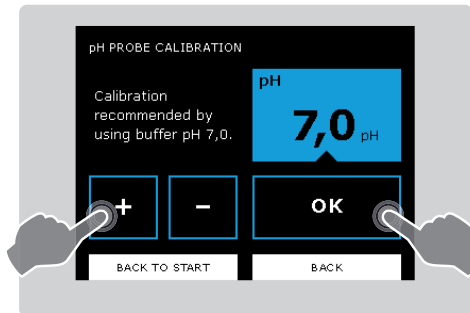
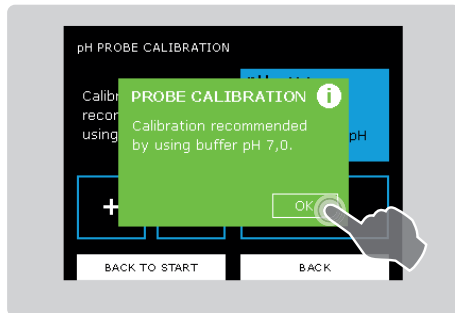

pH buffer 7,00 #12065



RECOMMENDATION:

for precision calibrating use the test buffer pH 7,00.

Choose the function of Your ASIN Aqua

- 1) Free chlorine probe CLF
- 2) Redox probe RX
- 3) Time dosing ml/m³ per hour or per day

- From the home screen select settings

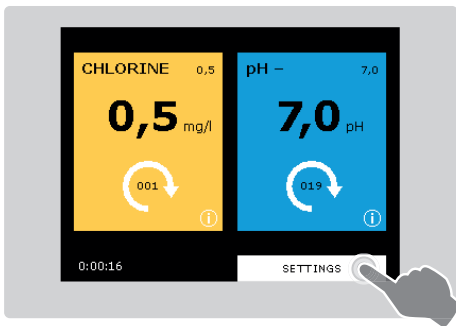

- then CHOOSE THE TYPE OF PROBE to reach the following screen.

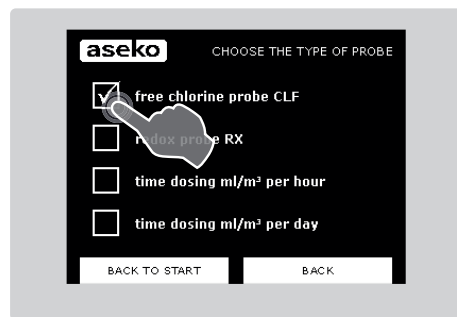
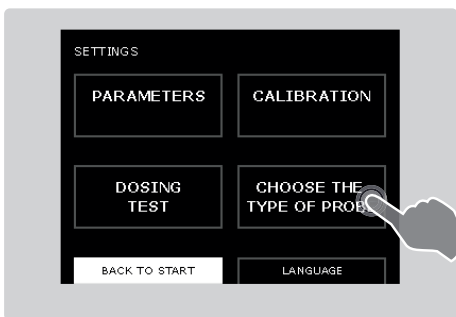

1) If You have free chlorine probe

Your Asin Aqua is already installed, connected to pool water and to chemical agents.

- Set up the chlorine level to 0,0 mg/l
- Set up the pH value to 7,0



- Manually adjust the chlorine level in your pool to 0,5 – 1,2 mg/l by using manually dosing from ASIN Aqua or hand dosing of Superchlorination agent directly to pool.

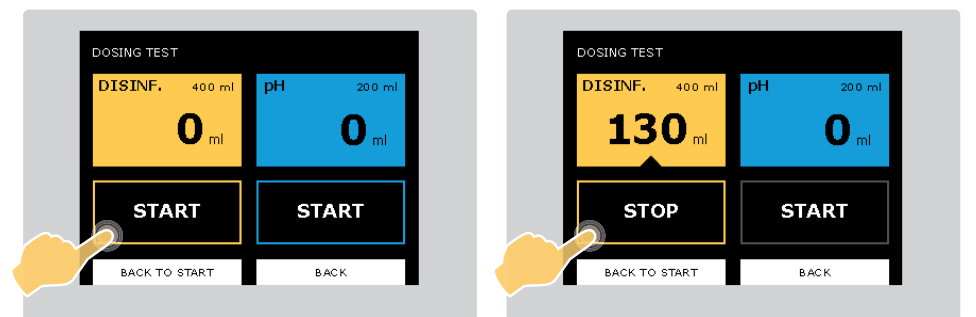

Wait 24 hours for the probe stabilization.

The first CLF calibration

- Using the Aseko test kit provided, manually check the chlorine level of your pool by taking a sample from the output stream of pool water.
- From the start screen of your ASIN Aqua select SETTINGS and then CALIBRATION.

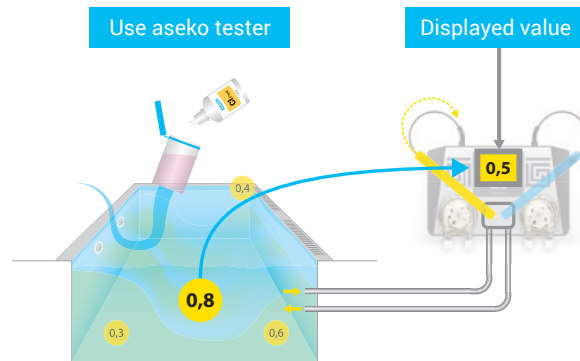

- Select the yellow chlorine box on the left of the screen. If the probe is broken or have any other malfunction the following notification is given.
- Compare the reading given on your ASIN Aqua with the reading taken manually. If different adjust the reading on the ASIN Aqua by pressing the + and – buttons so that they match and press OK to save

When your manual chlorine readings match the ASIN AQUA readings, your probe is accurately reading chlorine levels.

RECOMMENDATION:

Check your chlorine level in your pool once a week.

The table below gives the recommended levels of chlorine for your pool. This varies with the temperature of your pool and should never be less than 0.3mg/l.

Chlorine Level mg/l	Water Temperature
0.3 – 0.5	24 – 26 °C
0.5 – 0.8	26 – 32 °C
0.8 - 1	Over 32 °C

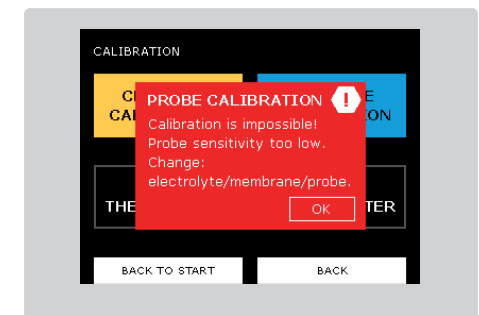
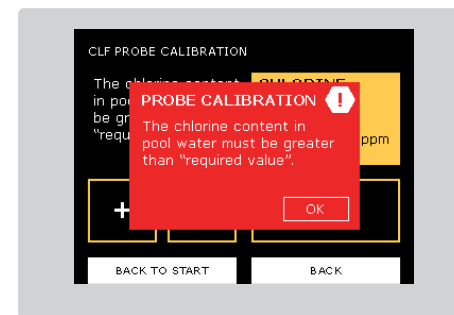
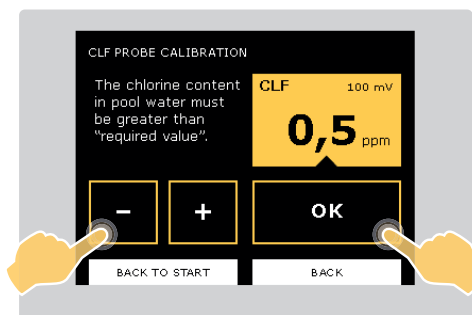
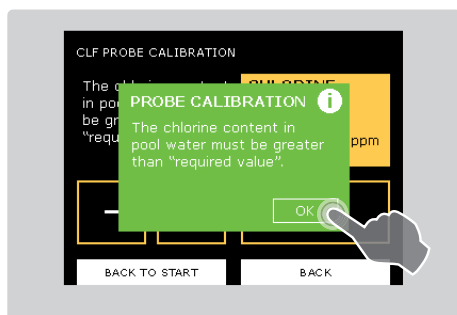
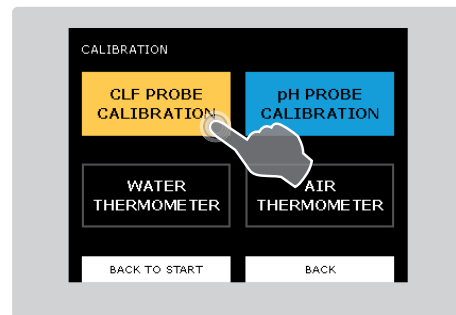
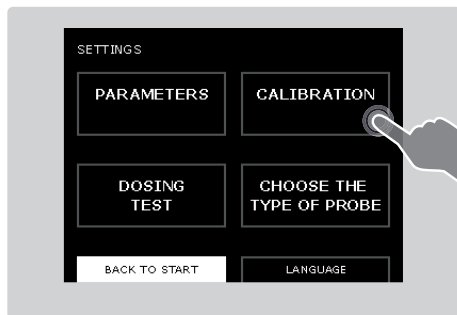

2) If You have redox probe

Your Asin Aqua is already installed, connected to pool water and to chemical agents.

- Set up the sanitation level on 650 mV
- Set up the pH value to 7,0

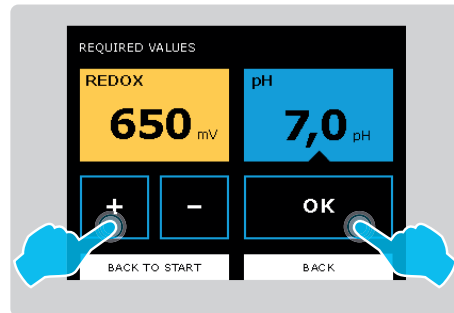
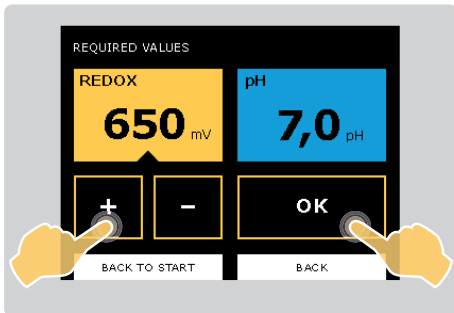

- Manually adjust the chlorine level in your pool to 0,5 – 1,2 mg/l by using manually dosing from ASIN Aqua or hand dosing of Superchlorination agent directly to pool.

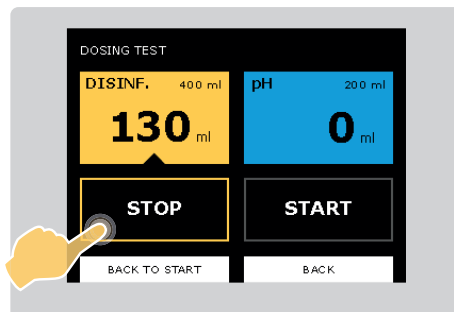
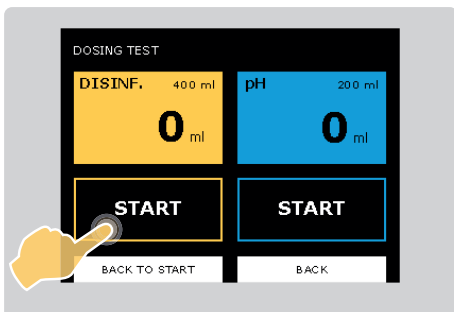

 Wait 24 hours for the probe stabilization.

Fine tune

- Manually check the chlorine level in the pool water.
- If the pool's chlorine level is too low or high, adjust the mV redox settings to fine tune your system.

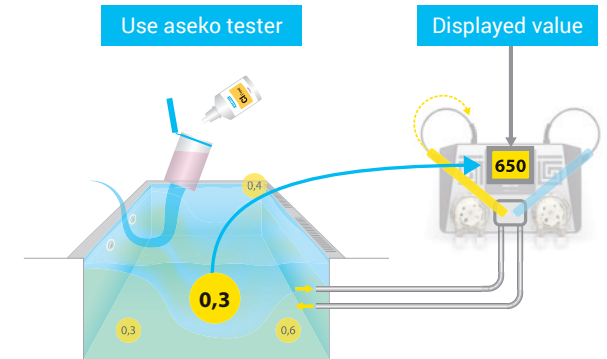

Each 0,1 mg/l matches 10 mV of redox.

EXAMPLE:

The pool water chlorine level is 0,3 mg/l = displayed value is 650 mV.

You want to have 0,5 mg/l.

You have to increase the set up value of redox from 650 mV to 670 mV.

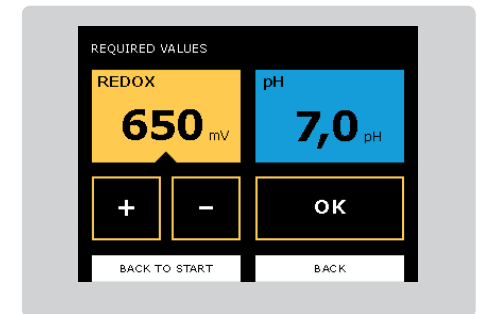

3) If you use time dosing without probe

Your Asin Aqua is already installed, connected to pool water and to chemical agents.

- Set up the sanitation dosing volume on 5 ml/m³ per hour if you use the chlorine sanitation agent.
- Set up the sanitation dosing volume on 10 ml/m³ per day if you use the active oxygen sanitation agent.
- Set up the pH value to 6,8

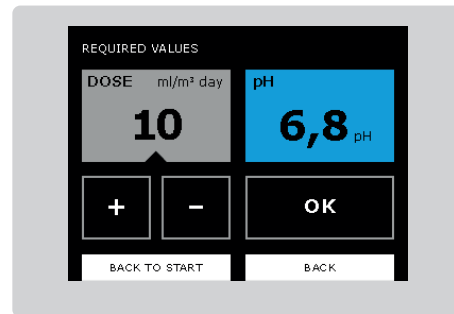
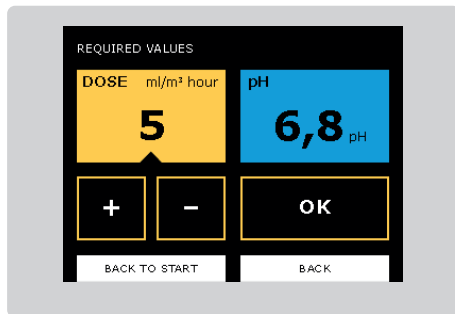

48 Wait 24 to 48 hours.

Sanostrips #12175



Fine tune

- Manually check the chlorine or active oxygen level in the pool water.
- Then increase or decrease the setup "dosing volume".

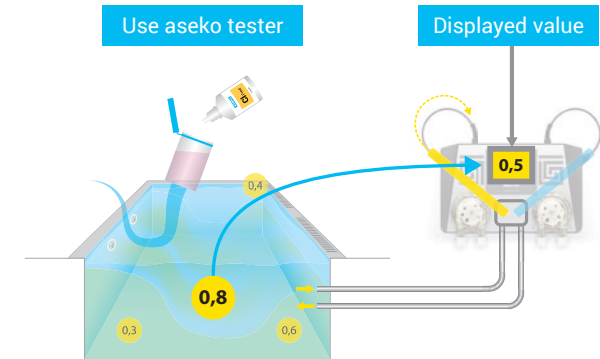

WARNING:

The filtration period must be set up as total runtime of ASIN Aqua per day.

Setting Your Pool's Parameters in page 13

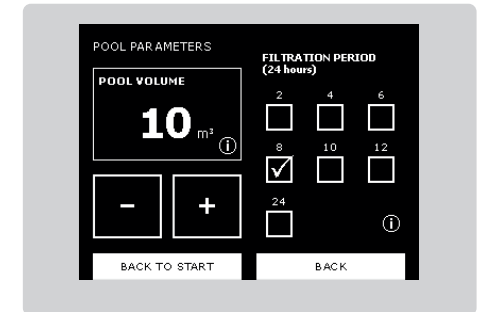

Safety functions

ASIN Aqua is equipped with safety functions that prevents pool from overdosing.

ASIN Aqua uses following safety functions:

- Maximum safety dose
- Too rapid pH change
- Dosing without a probe response

Maximal safety dose

If you setup water parameters correctly, ASIN Aqua calculates maximum volume of disinfection agent that can be dose in a hour. Thanks to this function extreme overdose is unlikely.

The maximal hourly safety dose varied from 1 to 11 ml/m³ per hour. For extreme conditions is 25 ml/m³ per hour.

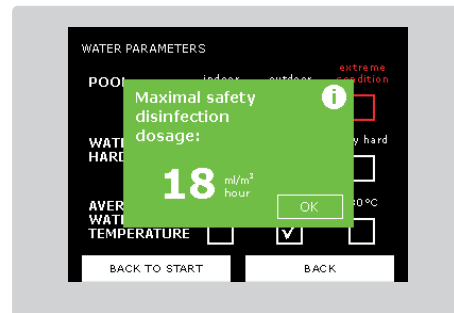
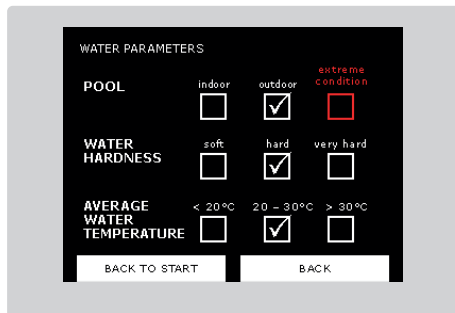

Too rapid pH change

It can be caused by heavy rain, filling of large volume of water or extreme use, if that happens ASIN Aqua stops dosing pH agent for 2 hours and when pH value settles ASIN Aqua starts dosing again.

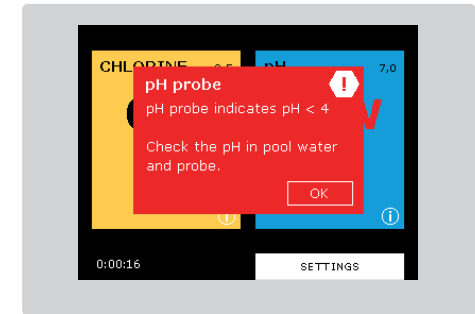

The pH change without probe response.

Depending on water hardness setting, ASIN Aqua reports error and stop dosing pH agent:

- Soft to moderately hard < 9 °dH. If there is a no change on the pH value ASIN Aqua stop dosing pH agent after **10 doses**.
- Hard 9–21 °dH. If there is a no change on the pH value ASIN Aqua stop dosing pH agent after **15 doses**.
- Very hard >21,01 °dH. If there is a no change on the pH value ASIN Aqua stop dosing pH agent after **25 doses**.

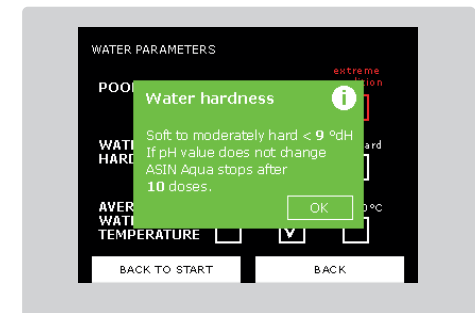

ASIN Aqua NET

Main difference between ASIN Aqua and ASIN Aqua NET is connection to the internet through LAN connector. And connector for external display.

Internet connection

The device is connected through LAN cable to the router. Data are sent in 10 seconds intervals to IP 217.11.244.139, port 10004, must NOT be blocked by firewall.

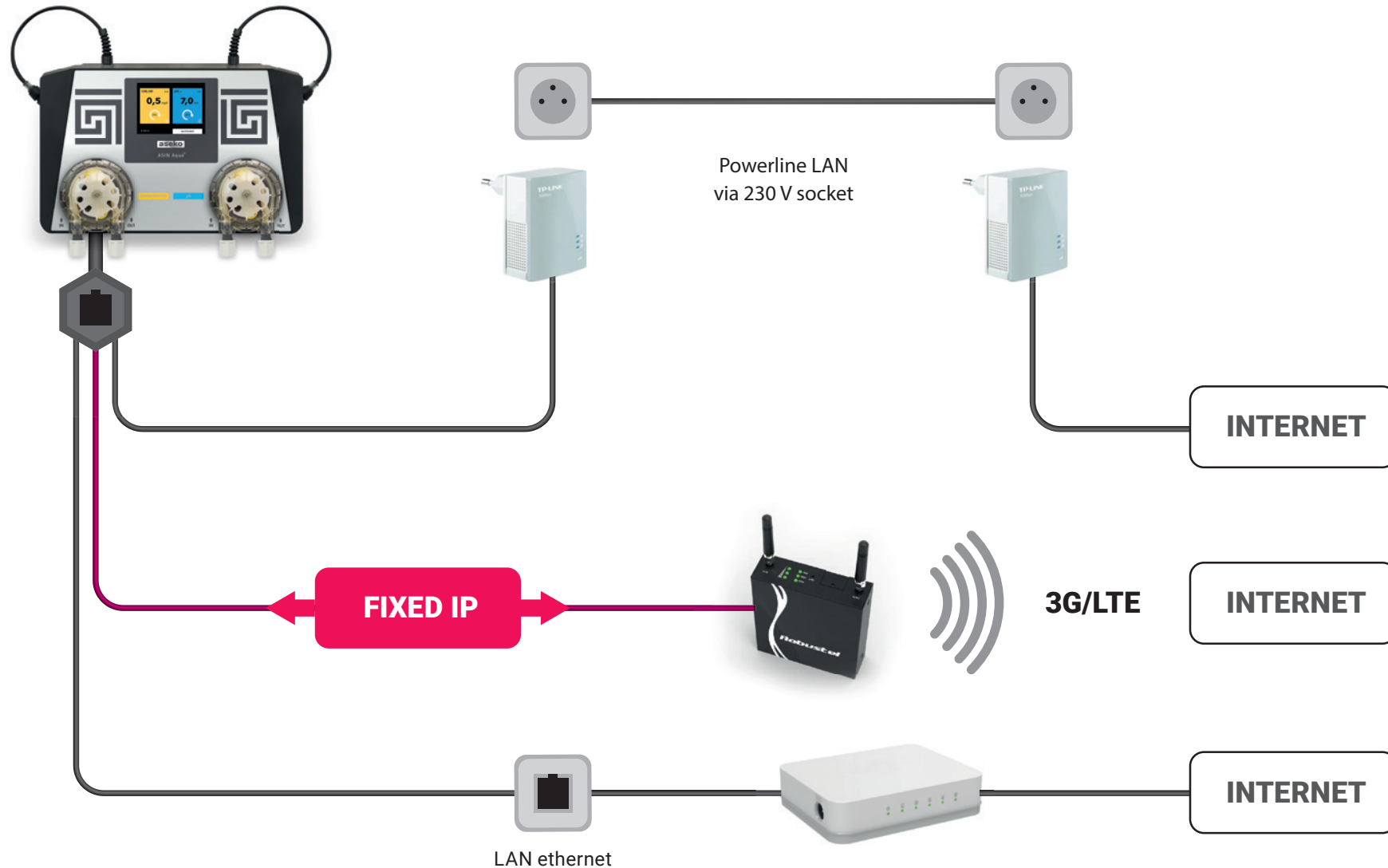

iPool Live

The app iPool Live shows data from the pool in real time on the screen of your iOS or Android device.

Allows set notifications when set parameters are exceeded.

Shows actual parameters and also history.

App is available for iOS and Android



iPool LIVE

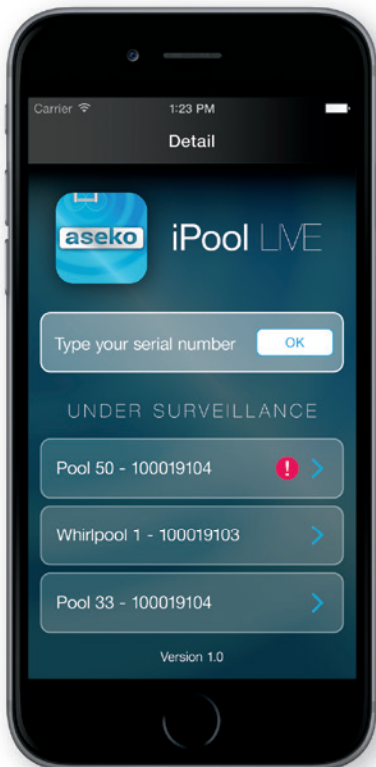

Enter serial number of the device you want to monitor.



You can set the notification when setup values are exceeded.



Time line shows all interactions with the unit.



Shows set time of the filtration, real time of the filtration and setup values.

ipool.aseko.com

Web application for detail monitoring of water quality by using well arranged graphs. Shows all measured data and actions up to 30 days back. All operations are monitored in real-time.

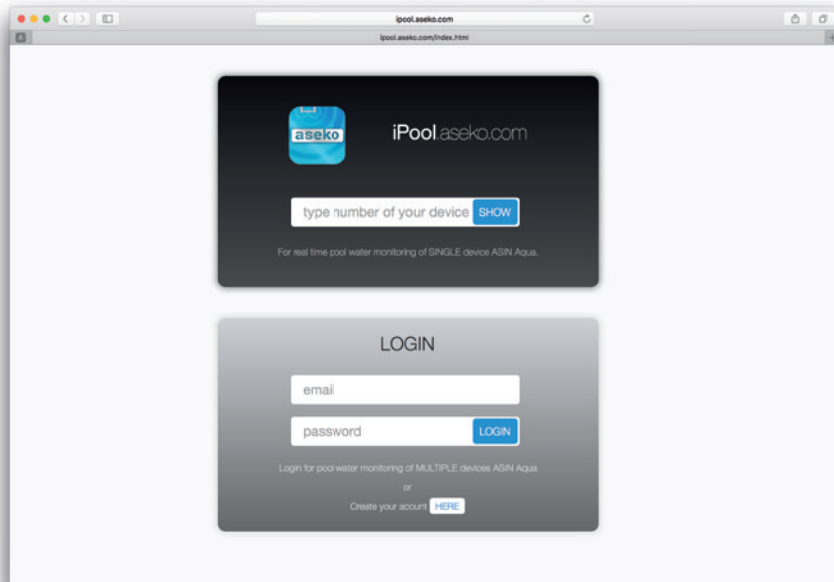

Login / registration screen.

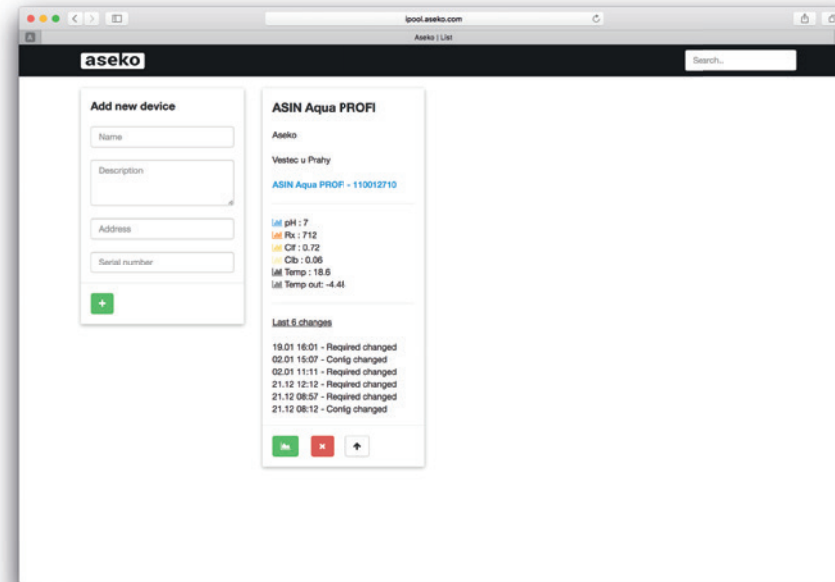

Overview of all devices.

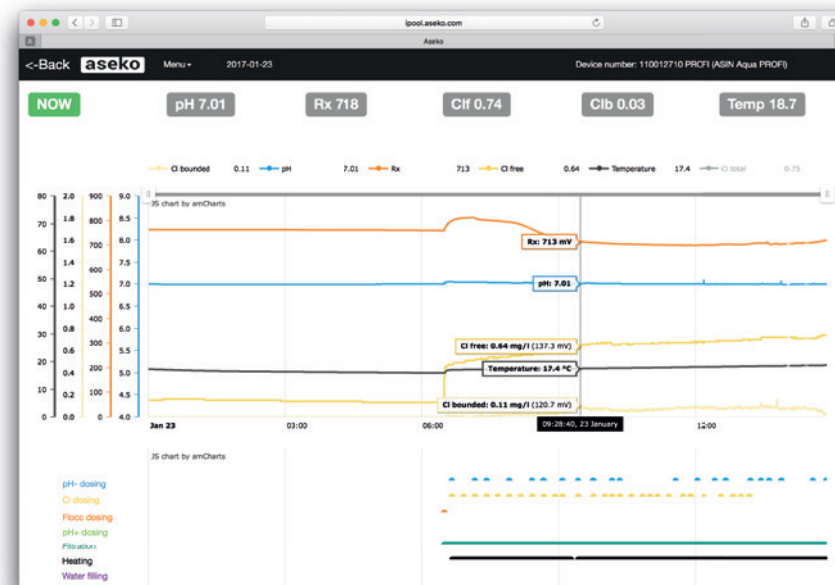

Detailed informations and graphs.

External touch display

Showing measured values of your pool water, humidity and temperature of the pool room where the display is installed and you can also change setup value of pH and chlorine. You can also chose which parameters you want to see on the display.

12048

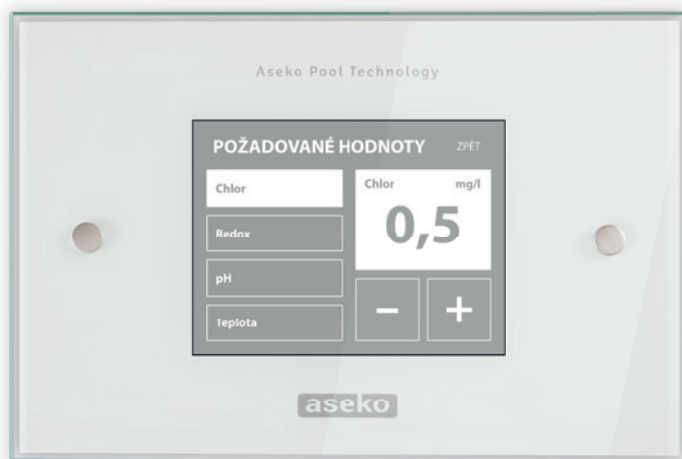

Thermometer connection

- Install temp. holder to the pipe system then insert the thermometer.
- Connect the cable (2m as standard, other lengths on request) into the connector at the bottom side of the device.

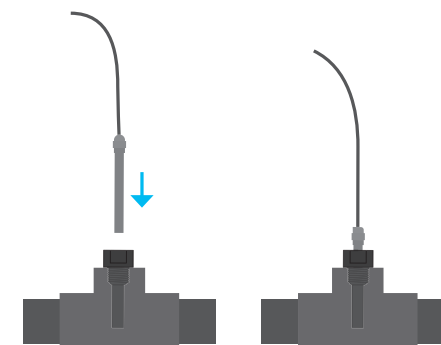

Thermometer calibration (ASIN Aqua NET)

1. In menu select SETTINGS then CALIBRATION.
2. Press THERMOMETER CALIBRATION.
3. Difference can be set using – and + button.



Maintaining ASIN Aqua

The ASIN Aqua requires regular visual inspection and maintenance to ensure optimal performance. The table below gives a list of areas to be regularly checked and recommendations for replacement time.

Spare part list

12005 Injection valve



13087 Replacement tube for injection valve



12073 Pump tube set



12071 CLF electrolyte



12029 CLF membrane



12065 Buffer pH 7,00



12052 CLF probe



12015 Redox probe



12014 pH probe



Pump Tube replacement

It is recommended to change the tube once a year in order to prevent the possible failure. The tube change is made in the following way:

- Turn the pump counterclockwise and remove it
- Loosen both ends of the tube and remove the tube
- Cut the tie strips and release the tube
- Use a new tube and secure it with new tie strips
- Insert the tube back to the pump and grease it with supplied grease
- Place the pump back

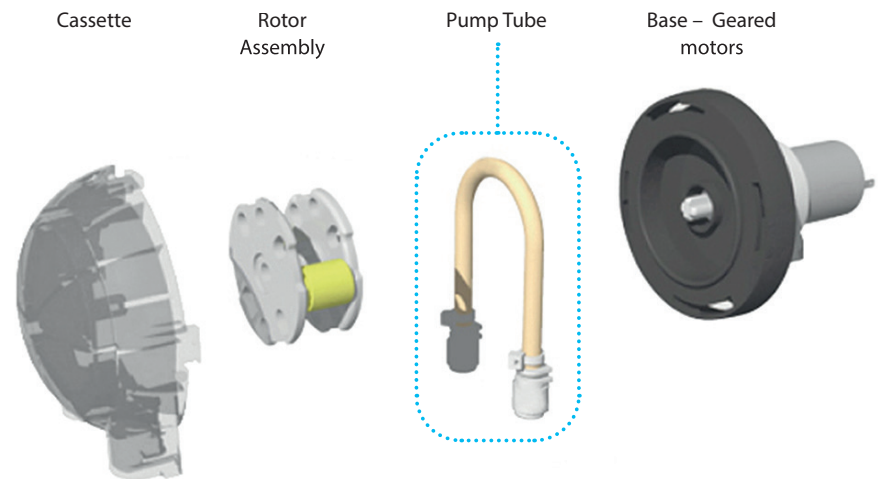

Item	Maintenance Procedure	Recommendation
pH and Chlorine Dosing Valves	<p>Check your valves regularly for blockages, damaged rubber seals and the build up of limescale.</p> <p>Check for damage to the clear plastic tubes.</p> <p>In case of very hard water, swop the clear plastic tube connecting the pH and chlorine to the valves every 2 weeks. This prevents the build up of limescale.</p> <p>WARNING: Mixing the pH and chlorine agents is extremely dangerous. Always wear personal protective safety equipment, gloves glasses and mask. After disconnecting tubes rinse in clean water before reconnecting.</p>	<p>Change your injection valves every 2 years for private pool use or every 1 year for public pools. # 12005</p>
Chlorine and pH Agent	<p>Regularly check the level.</p>	<p>Chlorine agent decomposes with time. Replace every 6 months</p>
PH and Chlorine Pumps	<p>Check inside the pumps for damage. The clear plastic tubes wear out during operation.</p>	<p>Replace tubes every 12 months. # 12073</p>

Item	Maintenance Procedure	Recommendation
CLF Probe	<p>Remove your CLF probe from your ASIN Aqua and clean off any dust and debris.</p> <p>Clean your probe with fresh water and wipe with a clean soft material.</p> <p>Check the sensitivity in mV in CALIBRATION MENU. If this is at 0,5 mg/l under 10 mV change the electrolyte or membrane module.</p>	<p>Change the electrolyte every 6 months. # 12071</p> <p>Change the membrane module every 1 years. # 12029</p>
Redox Probe	<p>Remove your Redox probe from your ASIN Aqua and clean off any dust and debris.</p> <p>Clean your probe with fresh water and wipe with a clean soft material.</p>	<p>Change your Redox probe every 1 – 2 years. # 12015</p>
pH Probe	<p>Remove your pH probe from your ASIN Aqua and clean off any dust and debris</p> <p>Clean your probe with fresh water and wipe with a clean soft material.</p>	<p>Change the pH probes every 1 – 2 years. # 12014</p>

ASIN Aqua error messaging

After **30** doses of chlorine agent without probe response displays this error message.

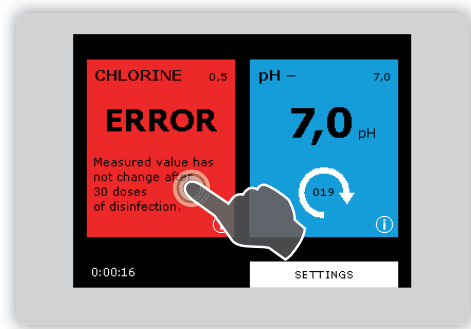

After **10/15/25** doses of pH agent without probe response displays this error message.

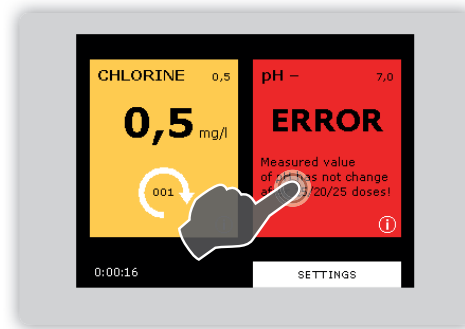

The agent has run out.

- Check the chlorine and pH agents regularly so that they do not run out. Chlorine agent concentration is 15-20%. This degrades over time and if exposed to direct sunlight.

The dosing pump does not work.

- Check that your dosing pumps are securely fitted and not loose.
- Check the connections to your dosing pumps are secure and not leaking.
- Check the clear plastic tubes inside the dosing pumps are not damaged or broken.
- To remove your dosing pumps from your ASIN Aqua, disconnect the clear plastic tubes, turn your dosing pump anti clockwise and pull away from your ASIN Aqua.

The dosing valve is not working.

- Check your dosing valves regularly for the build up of limescale.
- Make sure dust and dirt does not get into the containers of the chlorine and pH agent to avoid blockages and damage to the valves.
- Check the rubber seals of your valves regularly to prevent leaking.

Water does not flow to the probes.

- Check the clear plastic tubes connection to your ASIN Aqua Redox for damage and leaks.
- Check the connection of the clear plastic tubes to the valves for damage and leaks.
- Check the valves are properly connected to the water supply and that they are not damaged, blocked or in the closed position.

The probe does not work.

- Replace the pH probe each year.
- Ensure your probes are clean and free from dirt.
- Exposure to below 0° C conditions damages the probes.
- Regular cleaning of the probes maintains system accuracy.

pH and Chlorine display ERROR messages

- Press the red ERROR box to see the faults.
- Ensure the chlorine pump is connected to the chlorine agent and pH pump to pH agent.

Blank lined page for writing.

A series of 20 horizontal blue lines for writing.



Aseko Pool Technology



EN

ASIN Aqua[®]

REDOX, CLF, DOSE, SANOSIL

aseko.com